

# Read This First

## Operating Instructions

**1** Checking the package contents  
Sony CLIÉ™ Handheld components

**2** Setting up your Sony  
CLIÉ™ Handheld

**3** Performing the initial  
settings

**4** Basic operations of your  
Sony CLIÉ™ Handheld

Enjoying your CLIÉ™  
Handheld

Using applications

Personal Entertainment Organizer  
**PEG-NX70V**  
**PEG-NX60**

**CLIÉ™**



# About this manual

This manual provides an overview of your CLIÉ™ handheld's features including information about setting up your CLIÉ™ handheld and what you can do with your CLIÉ™ handheld.

## Checking the package contents

### Page 9

Make sure that all the accessories are supplied in the package.

## Sony CLIÉ™ Handheld components

### Page 11

Learn about the parts of your CLIÉ handheld and other accessories.

## Setting up your Sony CLIÉ™ Handheld

### Page 16

Charge your CLIÉ handheld and prepare for data transfer between your CLIÉ handheld and computer.

## Performing the initial settings

### Page 22

Configure the initial settings before operating your CLIÉ handheld.

## Basic operations of your Sony CLIÉ™ Handheld

### Page 29

Learn about the basic operations of your CLIÉ handheld.

## Enjoying your CLIÉ™ Handheld

### Page 55

Learn about your CLIÉ handheld's features.

## Using applications

### Page 68

Learn about the applications supplied with your CLIÉ handheld.



# WARNING

**To prevent fire or shock hazard, do not expose the unit to rain or moisture. To avoid electrical shock, do not open the cabinet. Refer servicing to qualified personnel only.**

**For customers in the U.S.A and Canada**

## Owner's Record

The model number and serial number are located on the back of the product. Record the model number and the serial number in the space provided below. Refer to them whenever you call upon your Sony dealer regarding this product.

Model No. \_\_\_\_\_  
Serial No. \_\_\_\_\_

The socket-outlet shall be installed near the equipment and shall be easily accessible.

## CAUTION

You are cautioned that any changes or modifications not expressly approved in this manual could void your warranty on this equipment.

This Class B digital apparatus complies with Canadian ICES-003.

Cet appareil numérique de la classe B est conforme à la norme NMB-003 du Canada.

## NOTE

This equipment has been tested and found to comply with the limits for a Class B digital device, pursuant to Part 15 of the FCC Rules. These limits are designed to provide reasonable protection against harmful interference in a residential installation. This equipment generates, uses, and can radiate radio frequency energy and, if not installed and used in accordance with the instructions, may cause harmful interference to radio communications. However, there is no guarantee that interference will not occur in a particular installation. If this equipment does cause harmful interference to radio or television reception, which can be determined by rotating the equipment off and on, the user is encouraged to try to correct the interference using one or more of the following measures:

- Reorient or relocate the receiving antenna.
- Increase the separation between the equipment and receiver.
- Connect the equipment into an outlet on a circuit different from that to which the receiver is connected.
- Consult the dealer or an experienced radio/TV technician for help.

If you have a question about this product, call the Sony Customer Information Center at keep on next line 1-877-760-7669; or write to the Sony Customer Information Center at 12451 Gateway Boulevard, Fort Myers, FL 33913. The number below is for FCC-related matters only.

## Declaration of Conformity

Trade Name: SONY

Model No.: PEG-NX70V/U

PEG-NX60/U

Responsible Party: Sony Electronics Inc.

Address: 680 Kinderkamack Road, Oradell, NJ 07649 USA

Telephone No.: 201-930-6972

This device complies with part 15 of the FCC Rules.

Operation is subject to the following two conditions:

- (1) This device may not cause harmful interference, and
- (2) This device must accept any interference received, including interference that may cause undesired operation.

The supplied interface cable must be used with the equipment in order to comply with the limits for a digital device pursuant to Subpart B of Part 15 of FCC Rules.

## RECYCLING LITHIUM-ION BATTERIES

Lithium-Ion batteries are recyclable.

You can help preserve our environment by returning your used rechargeable batteries to the collection and recycling location nearest you.

For more information regarding recycling of rechargeable batteries, call toll free 1-800-822-8837, or visit

<http://www.rbrc.org/>

**Caution:** Do not handle damaged or leaking lithium-ion batteries.



IN NO EVENT SHALL SONY BE LIABLE FOR ANY INCIDENTAL, INDIRECT OR CONSEQUENTIAL DAMAGES OR OTHER DAMAGES INCLUDING WITHOUT LIMITATION LOSS OF PROFITS, LOSS OF REVENUE, LOSS OF DATA, LOSS OF USE OF THE PRODUCT OR ANY ASSOCIATED EQUIPMENT, DOWNTIME, AND PURCHASER'S TIME RELATED TO OR ARISING OUT OF THE USE OF THIS PRODUCT, ITS HARDWARE AND/OR ITS SOFTWARE.

### On the supplied software

- Copyright laws prohibit reproducing the software or the software manual in whole or in part or renting the software without the permission of the copyright holder.
- In no event will SONY be liable for any financial damage or loss of profits, including claims made by third parties, arising out of the use of the software supplied with this product.
- In the event a problem occurs with this software as a result of defective manufacturing, SONY will replace it at SONY's option or issue a refund. However, SONY bears no other responsibility.
- The software provided with this product cannot be used with equipment other than that which it is designated for use with.
- Please note that, due to continued efforts to improve quality, the software specifications may be changed without notice.
- The software library incorporated in CLIE handheld is based in part on the work of the Independent JPEG Group.

Program © 2002 Sony Corporation, © 2002 Palm, Inc., or its subsidiaries. All rights reserved.  
Documentation © 2002 Sony Corporation

## CAUTION

Please contact your nearest Sony dealer regarding any problems you are experiencing with your Sony product.

## Notes

- Sony does not support third-party add-on applications. If you are having a problem with a third-party application, please contact the developer or publisher of that software.
- The illustrations in this manual may differ from the actual software.
- Explanations in this manual assume that you are familiar with basic operations of Windows®. For how to use your computer and operating system, please refer to their respective manuals.

Before using your CLIE handheld, be sure to read the accompanying End-User's License Agreement.

Sony, CLIE, "Memory Stick", "Magic Gate Memory Stick", Jog Dial, PictureGear Studio and their logos are trademarks of Sony Corporation.

Palm OS, Graffiti and HotSync are registered trademarks of Palm, Inc. and its subsidiaries, and Palm, Palm Powered, Palm Desktop, the Palm logo, the Palm Powered logo, the HotSync logo and Palm OS5 logo are trademarks of Palm, Inc and its subsidiaries.

Microsoft and Windows are registered trademarks of Microsoft Corporation.

MMX and Pentium are registered trademarks of Intel Corporation.

Pumatech, the Pumatech logo, IntelliSync and IntelliSync Lite are trademarks of Pumatech, Inc., that may be registered in some jurisdictions.

Adobe and Adobe Acrobat Reader are trademarks of Adobe Systems Incorporated.

Documents To Go is a registered trademark of DataViz, Inc.

Bluetooth is a trademark that is owned by the proprietor and used by Sony under license.

QuickTime and the QuickTime logo are trademarks of Apple Computer, Inc.

NetFront is a trademark of ACCESS CO, Ltd.

Contains Macromedia® Flash™ Player technology by Macromedia, Inc.,  
Copyright © 1995-2001 Macromedia, Inc. All rights reserved.

Macromedia, Flash and Macromedia Flash are trademarks or registered trademarks of Macromedia, Inc. in the United States and internationally.

This product includes fonts owned by TypeBank Co., Ltd. under license.

CompactFlash is a U.S. registered trademark of SanDisk Corporation.

All other trademarks are trademarks of their respective owners.

## Recycling Lithium-Ion batteries

Lithium-Ion batteries are recyclable.

You can help preserve our environment by returning your used rechargeable batteries to the collection and recycling location nearest you.

For more information regarding recycling of rechargeable batteries, call toll free 1-800-822-8837, or visit the website (<http://www.rbrcc.org/>).

When you dispose a CLIÉ handheld, follow the steps below for recycling batteries.

### How to remove the battery

- 1** Remove the screw from the side of the CLIÉ handheld with the Phillips screwdriver.
- 2** Remove the battery cover.

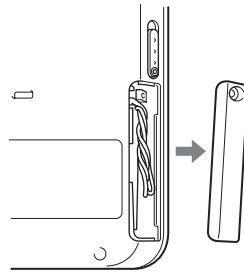
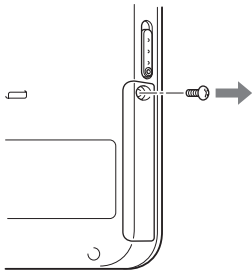

- 3** Pull the ribbon attached to the battery.
- 4** Remove the jack of the battery code from the CLIÉ handheld.

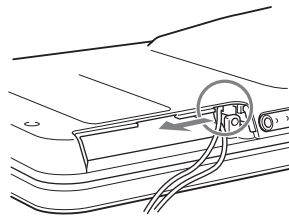
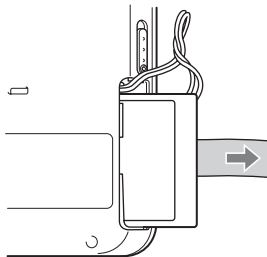

# Table of Contents

<b>Checking the package contents</b> . . . . .	<b>9</b>
<b>Sony CLIÉ™ Handheld components</b> . . . . .	<b>11</b>
Locating the parts of your Sony CLIÉ Handheld . . . . .	11
Changing the operating style. . . . .	13
Locating cradle components . . . . .	15
Locating the controls on the supplied audio remote control . . . . .	15
<b>Setting up your Sony CLIÉ™ Handheld</b> . . . . .	<b>16</b>
Charging your Sony CLIÉ Handheld . . . . .	16
Installing the Palm™ Desktop for CLIÉ software on your computer . . . . .	19
Connecting the cradle to your computer . . . . .	21
<b>Performing the initial settings</b> . . . . .	<b>22</b>
Turning on your Sony CLIÉ Handheld for the first time . . . . .	22
Setting the user name . . . . .	27
<b>Basic operations of your Sony CLIÉ™ Handheld</b> . . . . .	<b>29</b>
Basic operations . . . . .	29
Functions of parts . . . . .	31
Locating the components of the front panel . . . . .	40
Using applications. . . . .	44
Opening/Playing back files (CLIE Viewer) . . . . .	46
Entering data . . . . .	48
Exchanging and updating data using a HotSync® operation . . . . .	49
Resetting your Sony CLIÉ Handheld . . . . .	52
<b>Enjoying your CLIÉ™ Handheld</b> . . . . .	<b>55</b>
Enjoying image files . . . . .	55
Enjoying movies . . . . .	57
Viewing image files and movie files taken with “Memory Stick” compliant devices on your CLIÉ handheld . . . . .	59
Using voice recorder . . . . .	60
Listening to music. . . . .	61
Managing schedules (Date Book) . . . . .	62
Managing addresses and telephone numbers (Address) . . . . .	64
Exchanging the Date Book and Address data between your CLIÉ handheld and computer . . . . .	65
Viewing Microsoft® Word and Microsoft® Excel documents on your CLIÉ handheld (Documents To Go®) . . . . .	66
Connecting to the Internet . . . . .	67
<b>Using applications. . . . .</b>	<b>68</b>
Using CLIÉ Application Manual . . . . .	68
Installing add-on applications on your CLIÉ handheld . . . . .	70
Introducing add-on applications . . . . .	71

*Continued on next page*

**Troubleshooting . . . . . 86****Preventing problems . . . . . 86****Solving problems . . . . . 88****Getting Help . . . . . 89****Additional information . . . . . 91****Notes on use . . . . . 91****Specifications . . . . . 94****INDEX . . . . . 98**

## Notes on this manual

- This manual supports PEG-NX70V and PEG-NX60.
  - The illustrations in this manual are for PEG-NX70V unless specified otherwise.
  - Differences between PEG-NX70V and PEG-NX60 are specified in each corresponding section.
- Screen pictures in this manual may be different from the actual displays in the supplied software.
- Contents of this manual are written for users with basic operating skill of Windows. For details about computer operation, refer to the manual for the computer.

## About display (LCD)

The LCD of your CLIÉ handheld is designed with precision techniques; however, the followings may occur as a result of the inherent nature of LCD's, it is not a malfunction.

- Black, red, blue, or green dots appear.
- Brightness of the display is lacking in uniformity depending on the angle of view.

## Testing for taking pictures/movies and recording voices

Prior to taking pictures/movies and recording voices, check that those files are normally saved in your CLIÉ handheld or a "Memory Stick" media by testing.

## No guarantee for lost data or damaged data

Sony does not provide any guarantee for lost data or damaged data caused by improper operations.

## Copyrights

Television programs, films, video tapes, and other materials may be copyrighted. Unauthorized recording of such materials may be contrary to the provision of the copyright laws.



# Checking the package contents

Please check the accessories in the package at the beginning.

## CLiÉ handheld (1)

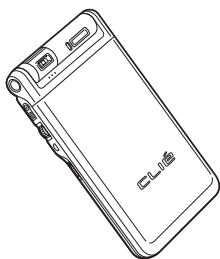

The illustration is for PEG-NX70V.

## Cradle (1)

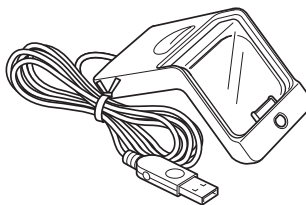

## AC power adapter (1)

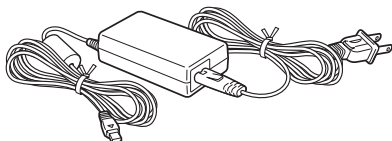

## Headphones (1)



## Stylus (1)



The stylus is stored in your CLiÉ handheld at the factory.

## Audio remote control (1)



### **Plug adapter (1)**



### **Plug adapter attachment (1)**

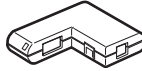

### **Protect card (1)**

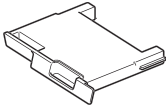

The protect card is stored in your CLiE handheld at the factory.

### **Installation CD-ROM (1)**

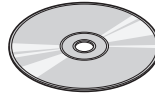

### **Strap (1)**

Refer to the illustration below to attach the strap.

### **Read This First - Operating Instructions (1, this manual)**

### **Troubleshooting Q&A (1)**

### **Customer Registration Guide (1)**

### **Customer Registration card (Warranty)**

### **Graffiti label (1)**

### **Software licenses agreement (1)**

### **Other printed materials**

Make sure that the package contains all of the listed accessories. If any item is missing, contact the Sony Customer Information Service Center or a Sony dealer.

### **Attaching the strap**

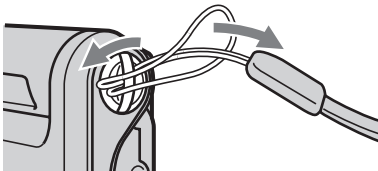

# Sony CLIÉ™ Handheld components

Each part of the CLIÉ handheld and of the supplied accessories is explained.

## Locating the parts of your Sony CLIÉ Handheld

### ..... Front panel

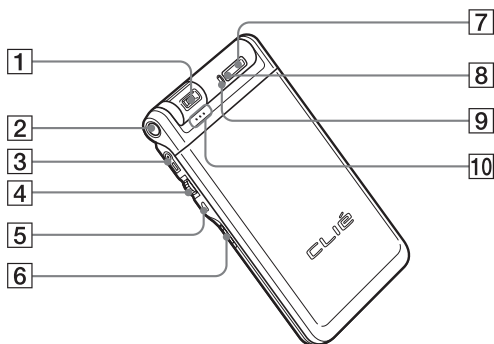

- |  |                                 |
|--|---------------------------------|
| <b>1</b> Camera (PEG-NX70V only)<br>(Page 33)  | <b>5</b> BACK Button (Page 34)  |
| <b>2</b> CAPTURE/REC Button<br>(for PEG-NX70V)<br>(Page 32, 55, 58, 60)<br>VOICE REC Button<br>(for PEG-NX60)<br>(Page 32, 60) | <b>6</b> HOLD Switch (Page 33)  |
| <b>3</b> Headphone jack (Page 61)  | <b>7</b> POWER Button (Page 31) |
| <b>4</b> Jog Dial™ navigator<br>(Page 30)  | <b>8</b> POWER LED (Page 32)    |
|  | <b>9</b> REC LED (Page 33)      |
|  | <b>10</b> Microphone (Page 60)  |

Continued on next page  
.....

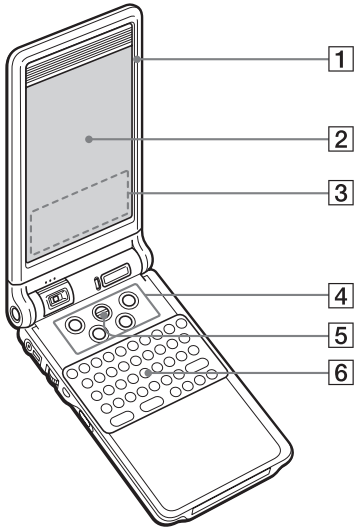

- 1 Display Panel (Page 13)**
- 2 Screen (Page 40)**
- 3 Graffiti Writing Area (Page 40)**
- 4 Application Buttons (Page 45)**
- 5 Scroll Button (Page 34)**
- 6 Hardware Keyboard (Page 37)**

.....

## Back panel

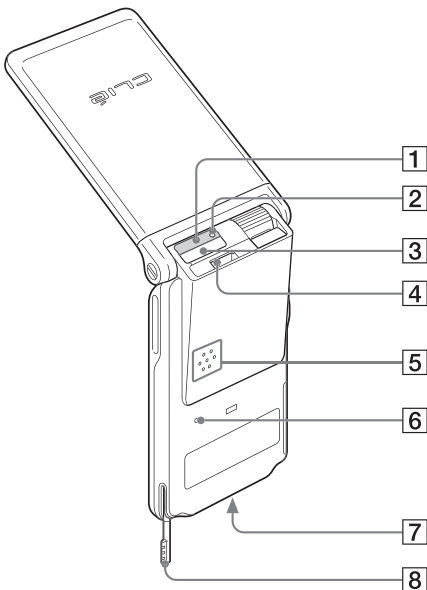

- 1 IR port (Page 36)**
- 2 "Memory Stick" LED (Page 35)**
- 3 "Memory Stick" Slot (Page 35)**
- 4 Wireless Communication Slot (Page 38)**
- 5 Speaker (Page 43)**
- 6 Reset Button (Page 52)**
- 7 Interface Connector (Page 16, 17)**
- 8 Stylus (Page 29)**

# Changing the operating style

Your CLIÉ handheld can be used with the display panel set in three different styles.

## Carrying style

Set your CLIÉ handheld to the “carrying style,” when carrying it around in your baggage or pocket to guard the screen from damage.

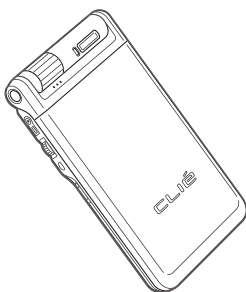

## Opened style

Set your CLIÉ handheld to the “opened style,” when you enter a lot of data with the hardware keyboard.

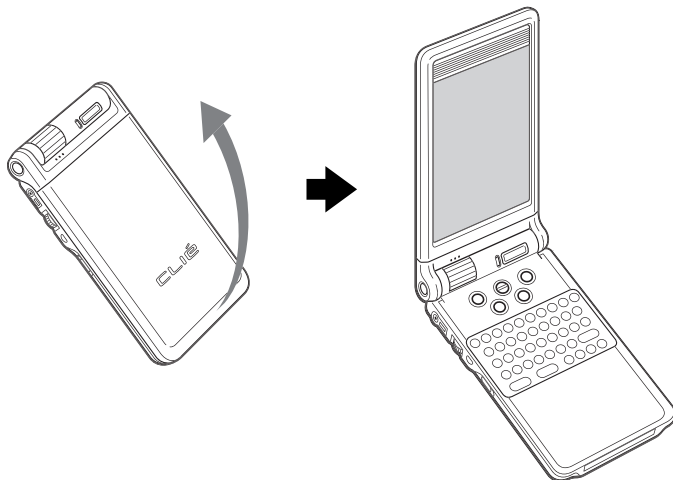

Open the display panel until it clicks into place.

## Turned style

Set your CLIÉ handheld to “turned style” to make it compact when you operate it with the Stylus or use it in the Camera mode (PEG-NX70V only).

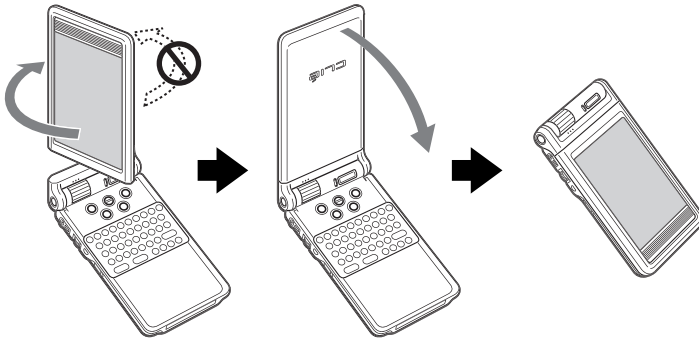

Open the display and rotate it clockwise until it clicks into place

Fold the display over the keyboard

### Note

Do not turn the display panel in any direction other than that specified and do not put too much force.

### Closing the display panel

Close the display panel by rotating it counterclockwise.

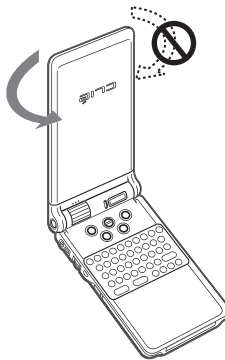

## Locating cradle components

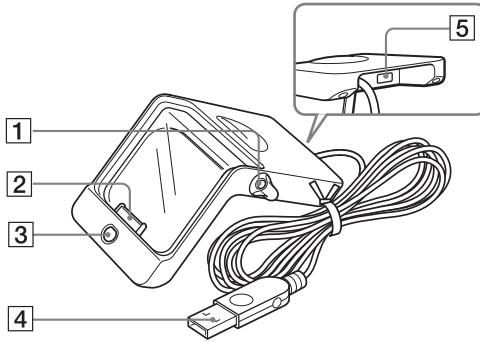

- |   |  |
|---|--|
| <p><b>1 Stylus holder</b><br/>Stores the stylus.</p> <p><b>2 Interface Connector</b><br/>(Page 16)</p> <p><b>3 HotSync Button</b> (Page 28, 49)</p> | <p><b>4 USB Connector</b> (Page 21)</p> <p><b>5 AC Adapter Connector</b><br/>(Page 16)</p> |
|---|--|

## Locating the controls on the supplied audio remote control

You can use the audio remote control when you play back music or audio movies with an application such as Audio Player or Movie Player.

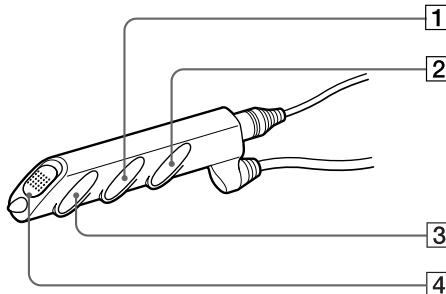

- |  |  |
|--|--|
| <p><b>1 ◀◀/▶▶ Button</b></p> <p><b>2 Volume Control Button</b></p> | <p><b>3 ▶/■ Button</b></p> <p><b>4 HOLD Switch</b></p> |
|--|--|

➔ For details on operating each application, refer to “CLIE Application Manual” on the computer.

# Setting up your Sony CLIÉ™ Handheld

Follow these steps before you start using your CLIÉ handheld:

- 1 Charging your CLIÉ handheld.
- 2 Installing software on your computer.
- 3 Connecting your computer to the CLIÉ handheld.

## Step 1: Charging your Sony CLIÉ Handheld

### Note

Before you use your CLIÉ handheld for the first time, make sure to charge it.

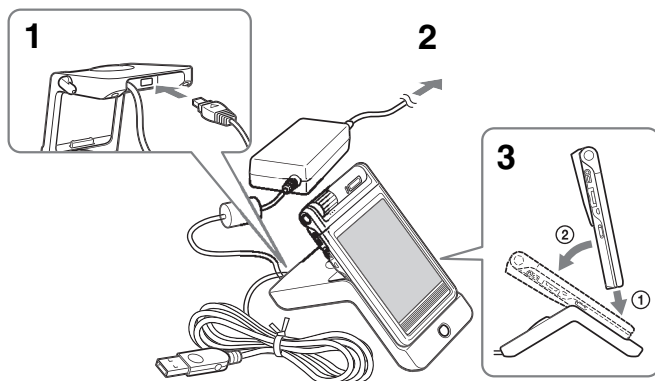

- 1 Connect the AC adapter to the cradle.
- 2 Connect the AC adapter to the wall outlet.



- 3 Insert your CLIE handheld at an angle in the cradle and lay it back to fit into place.  
The POWER LED indicator of your CLIE handheld turns on.

It takes about four hours for your CLIE handheld to be fully charged for the first time. The POWER LED indicator of your CLIE handheld turns off when charging is completed.

#### Tip

If your CLIE handheld is charged frequently, subsequent charges will require less time.

#### Notes

- If the battery in your CLIE handheld is fully discharged, all data stored on the memory in your CLIE handheld will be lost.
- While charging the CLIE battery on the cradle, do not connect the line out jacks of external devices such as a computer to the Headphone jack of your CLIE handheld, as malfunction may occur.

### Charging without using the cradle

You can charge your CLIE handheld with the plug adapter, without using the cradle.

#### Attaching the plug adapter

- 1 Connect the AC adapter to the DC IN jack of the plug adapter (①), and then connect the plug adapter to the interface connector of your CLIE handheld (②).

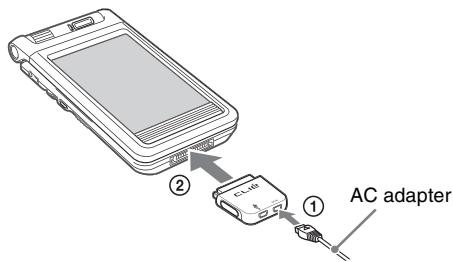

Continued on next page

**2** Connect the AC code to the AC adapter.

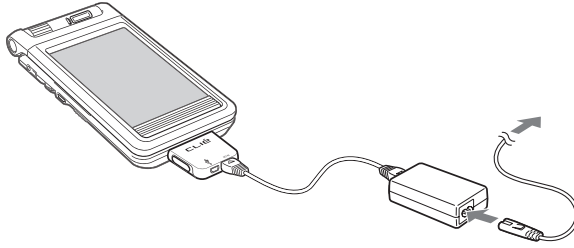

### **How to connect the supplied plug adapter attachment**

Connect the supplied plug adapter attachment as illustrated.

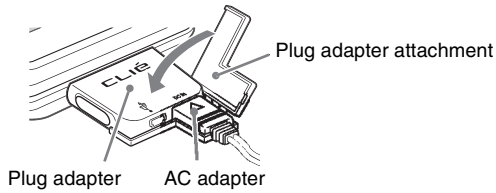

### **How to remove the plug adapter**

Remove by pressing the plug adapter on both sides as illustrated.

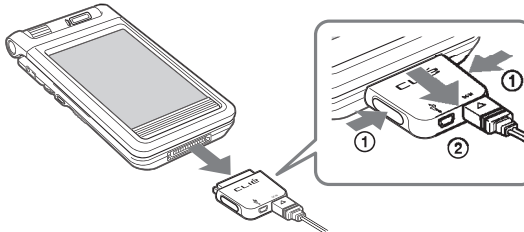

## Step 2: Installing the Palm™ Desktop for CLIÉ software on your computer

The Palm™ Desktop for CLIÉ software in the supplied CD-ROM is required to be installed on your computer. The software is used for data transfer between your CLIÉ handheld and computer, or handling data such as Address Book on your computer.

- For details on the system required on a computer, refer to “System required on a computer” on page 96.

### Notes

- **Do not connect the cradle to a USB connector of your computer before installing the Palm™ Desktop for CLIÉ software. The installation of the software might not be performed correctly.**
- Do not simply copy the Palm™ Desktop for CLIÉ software files to your computer’s hard disk. You must use the installer and follow the procedures described in this section to install the software.
- If you use Windows 2000 Professional or Windows XP, log on with a User Name in the Administrators group before installing the software.
- If you are already using a Sony CLIÉ Handheld, follow the procedures described in this section to upgrade to the new version of Palm™ Desktop for CLIÉ software. **Do not uninstalling the old version manually.**
  - \* If you use PEG-N710C or PEG-S300, refer to the official Sony CLIÉ Website. (Refer to the back cover of this manual for the URL.)
  - For details, refer to “Using data with another Sony CLIÉ Handheld” in “Handbook.”

### 1 Exit all applications running on Windows®.

You should quit all applications that automatically run at startup, such as fax communication software, anti-virus tools, screensavers, and the Microsoft® Office Shortcut Bar.

### 2 Insert the Installation CD-ROM into the CD-ROM drive of your computer.

The installation launcher window is displayed.

### 3 Click Install Palm Desktop for CLIÉ.

The setup program starts and the Welcome screen is displayed.

### 4 Click Next.

The Palm™ Desktop for CLIÉ software installation begins.  
Follow the on-screen instructions.

**5** Select the software you will use to synchronize your CLIÉ handheld with your computer.

If you select “Synchronize with Palm Desktop for CLIÉ,” Intellisync Lite will not be installed. If you select “Synchronize with Microsoft Outlook or Lotus Organizer,” Palm Desktop and Intellisync Lite will be installed.

**6** Click Next.

The Setup Type window is displayed.

**7** Select the setup type (Typical or Custom) and the destination folder.

If you wish to synchronize PEG-S300 or PEG-N710C with your CLIÉ handheld (PEG-NX70V or PEG-NX60), follow the steps below:

- ① Select Custom for the setup type and click Next.
- ② On the select components screen, make sure that USB Switcher is selected.
- ③ Follow the on-screen instructions until setup is complete.

When you follow the on-screen instructions, the Create User Account screen is displayed.

**8** Fill in the user name in the Create User Account screen.

**9** Click Next.

The Install Tool dialog box closes, then the Mail Setup dialog box is displayed.

**10** Follow the on-screen instructions to finish installing Palm Desktop.

**11** Fill in the customer registration following the on-screen instructions.

You need Internet access for the online customer registration.

You can take advantage of Sony’s commitment to quality customer support and 9 months of the extended limited warranty for a total of 12 months from the original date of purchase when you register your CLIÉ handheld.

**12** Perform an operation check for the HotSync feature following the on-screen instructions.

In this step, you perform an operation check for the HotSync feature (page 49). Please read the on-screen instructions carefully.

**13** Click Finish.

**Installing the Palm™ Desktop for CLIÉ software on your computer is completed.**

## Step 3: Connecting the cradle to your computer

When you complete the Palm™ Desktop for CLIÉ software installation, connect the cradle to a USB connector on your computer to synchronize the information on your CLIÉ handheld with the Palm™ Desktop for CLIÉ software on your computer.

### Connect the cradle to your computer

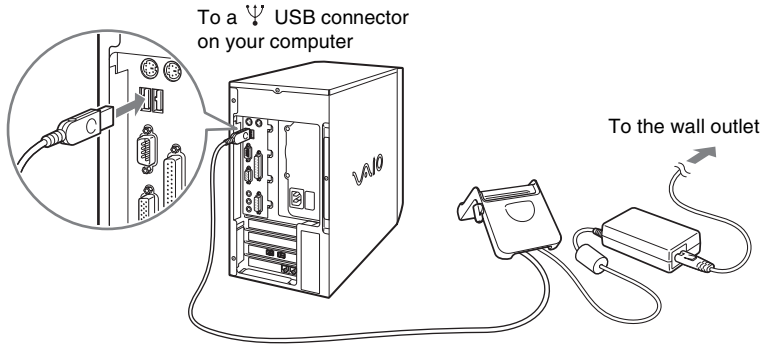

#### Note

Make sure that you directly connect the cradle to a USB connector on your computer. A HotSync® operation may not be performed normally if you connect to a computer via a USB hub.

# Performing the initial settings

The first time you turn on your CLIÉ handheld, the initial settings are required before operating your CLIÉ handheld. Follow the on-screen instructions to configure the initial settings and to get accustomed to operations on your CLIÉ handheld.

## Step 1: Turning on your Sony CLIÉ Handheld for the first time

### 1 Press the POWER button.

Your CLIÉ handheld turns on, and the **Welcome** screen appears.

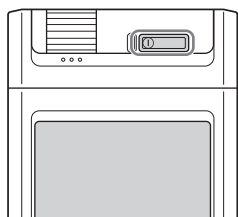

Press the POWER button

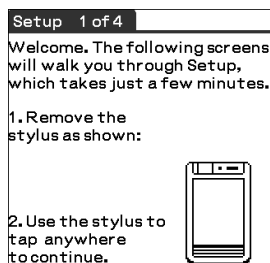

#### Tip

#### When you cannot turn on your CLIÉ handheld

- Is the HOLD switch (page 33) set to HOLD?
- Did you charge your CLIÉ handheld following the steps on page 16 ?
- ➔ For details, refer to the supplied manual "Troubleshooting Q&A."
  
- If you cannot turn on your CLIÉ handheld even after charging it, perform a soft reset (page 52).

## 2 Take out the Stylus.

You can use the stylus to enter data or to select applications.

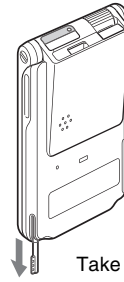

Take out the Stylus

### Notes

- Always use the point of the stylus for tapping or making strokes on the CLIÉ handheld screen. Never use a real pen, pencil, or other sharp object to write on the screen.
- When you put the stylus back in its holder, push it in until it clicks into place.

## 3 Press lightly on the screen with the stylus.

This action is called “tapping.”

The digitizer calibration screen appears. Calibration aligns the internal circuitry of the CLIÉ handheld with its touch-sensitive screen so your CLIÉ handheld can detect the task you want to perform when you tap an item on the screen.

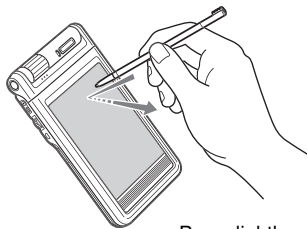

Press lightly on the screen (Tap)

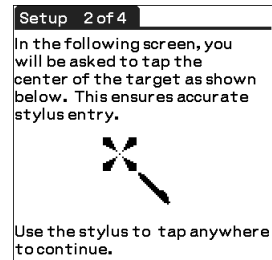

#### 4 Following the on-screen instruction, tap the center of the displayed mark.

##### Note

If the digitizer is not configured correctly, the scroll bar may not operate properly, “tapping” may not work as expected, or other problems may occur. For re-configuring the digitizer, refer to “Customizing your Sony CLIÉ Handheld: Adjusting the digitizer” in “Handbook.”

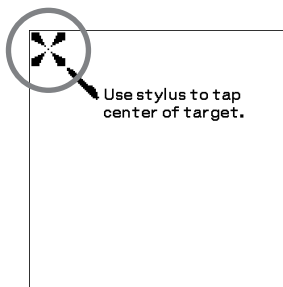

After calibration is completed, a screen for setting the time and date appears.

#### 5 Tap the **Set Time** box. The **Set Time** screen appears.



#### 6 Tap the arrow ▲ or ▼ to set the hour to the current time.



#### 7 Tap each number of the minute, and then tap the arrow ▲ or ▼ to set the minutes.

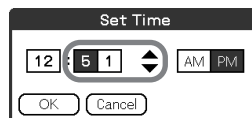



- 8** Tap **OK**.  
The **Set Time** screen closes.

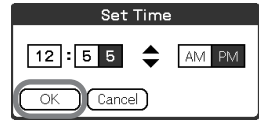

- 9** Tap the **Set Date** box.  
The **Set Date** screen appears.



- 10** Tap the arrow ◀ or ▶ next to the year to select the current year.

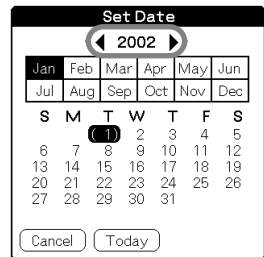

- 11** Tap the current month and then tap the current date.  
The **Set Date** screen closes.

- 12** Tap the **Time Zone** box.  
The **Set Time Zone** screen appears.

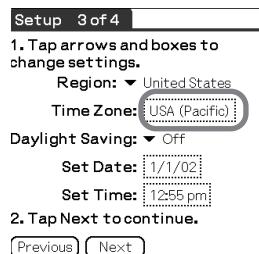

**13** Tap the region to set the time zone and then tap **OK**.



**14** Tap the arrow ▼ next to **Daylight Saving** and select **ON** or **OFF**.



**15** Tap Next.

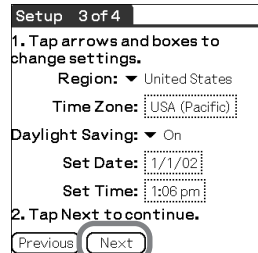

**16** Tap Next.

The **Enter Data** screen appears.

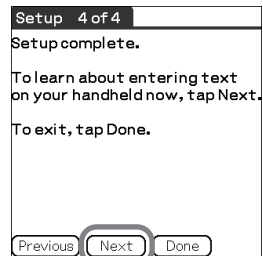

## 17 Tap Done.

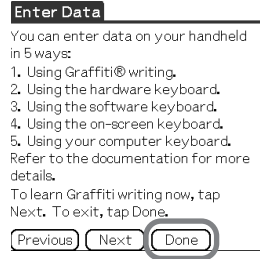

The initial settings are complete, and the CLIE Launcher screen appears.

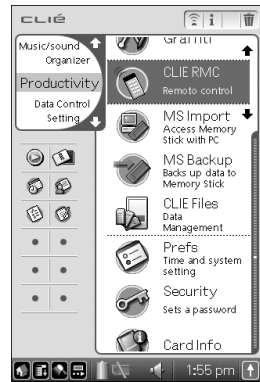

**Initial settings are complete.**

## Step 2: Setting the user name

- 1 Place your CLIE handheld on the cradle.

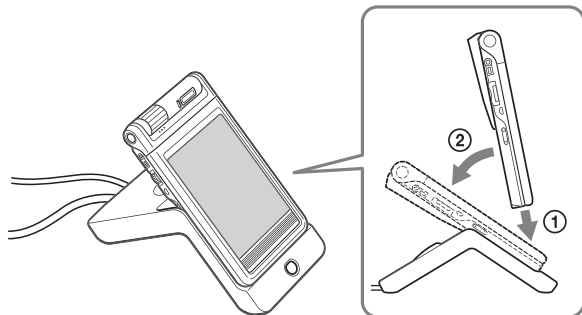

*Continued on next page*

- 2** Press the HotSync  button on the cradle.

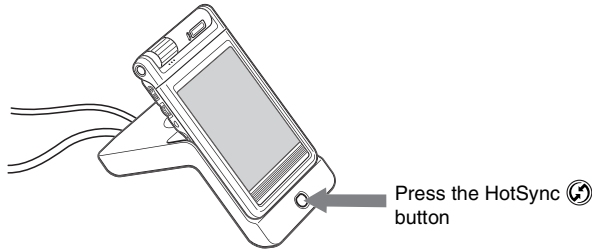

The USB Driver Installation starts automatically.

- 3** When the New User dialog box is displayed on your computer window, enter your user name.  
Enter the user name that you prefer.

**Note**

**When you have already used another CLIÉ handheld**

Every handheld should have a unique name. To prevent loss of user's records, never try to synchronize more than one handheld to the same user name.

**Tip**

**When you transfer data between CLIÉ handhelds**

Refer to "Using data with another Sony CLIÉ handheld" in "Handbook."

- 4** Click OK on your computer window.  
A beep sounds and the HotSync<sup>®</sup> operation starts.  
Your user name selected in step 3 is transferred to the CLIÉ handheld.  
When the HotSync<sup>®</sup> process is complete, a message showing the HotSync<sup>®</sup> operation completion is displayed on your CLIÉ handheld.

**Setup is completed!**

# Basic operations of your Sony CLIÉ™ Handheld

This chapter describes how to start applications, enter data, and perform other basic operations.

## Basic operations

### ..... Using the stylus

With your CLIÉ handheld, you can use the supplied stylus to enter characters or specify an application you want to run.

#### Taking out the stylus

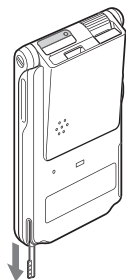

The stylus is stored in the holder on the keyboard panel of your CLIÉ handheld.

#### **Note**

To avoid losing the stylus, always put it back in its holder on your CLIÉ handheld after use.

#### Tapping

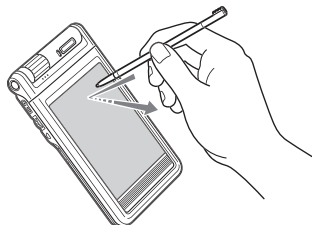

The action of pressing lightly on the screen with the stylus is called “tapping.”

## Dragging

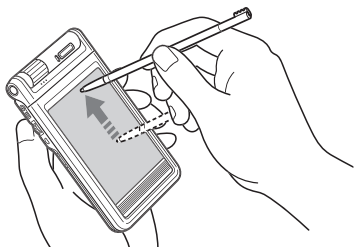

Just as you can drag the mouse to select (and drag) text or move objects on your computer, you can use the stylus to drag an item on the screen of your CLIÉ handheld. Press the stylus lightly on the item, and move it along the screen surface.

## Using the Jog Dial™ navigator

Your CLIÉ handheld is equipped with a Jog Dial™ navigator, which allows you to perform all major operations without the stylus. You can operate your CLIÉ handheld using the Jog Dial™ navigator with just one hand.

### Rotating the Jog Dial™ navigator



Rotate the Jog Dial™ navigator to select various items or to select an application to start.

### Pressing the Jog Dial™ navigator



Press the Jog Dial™ navigator to decide the selected item or to run the selected application.

### Rotating while holding down the Jog Dial™ navigator

Some applications support operations executed by rotating while pressing the Jog Dial™ navigator.

# Functions of parts

## POWER Button

### Turning on your CLIÉ handheld

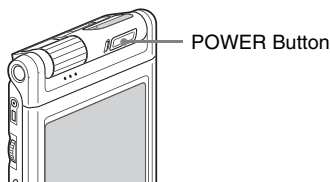

#### Press the POWER button.

Your CLIÉ handheld turns on and the last screen you viewed is displayed. When your CLIÉ handheld turns on, the POWER LED (page 32) indicator lights green.

#### Tip

When you turn on your CLIÉ handheld for the first time, the Setup screen appears (page 22).

#### Note

When you cannot turn on your CLIÉ handheld, make sure that if the HOLD switch is not in the HOLD position.

If you try to turn on your CLIÉ handheld while the HOLD switch is in the HOLD position, the POWER LED indicator blinks green three times.

### Turning off your CLIÉ handheld

Press the POWER button again.

#### Tip

You do not have to save data, quit an application, or perform any of the other shutdown procedures that your computer requires.

### Pressing the POWER button for more than two seconds

You can switch on/off the backlight of the LCD.

.....

## POWER LED

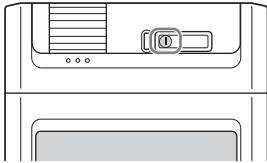

LED indicator shows the status of your CLIÉ handheld by its color.

LED	The status of your CLIÉ handheld
Lights green	The power is ON.
Lights orange	The battery is being charged.
Blinks orange	Alarm notifies you at a given time if you have made an alarm setting in an application, such as Date Book.
Blinks green (three times)	The HOLD switch is in the HOLD position. (Blinks when you try to turn on your CLIÉ handheld)
OFF	The power is OFF.

.....

## CAPTURE/REC Button (for PEG-NX70V) VOICE REC Button (for PEG-NX60)

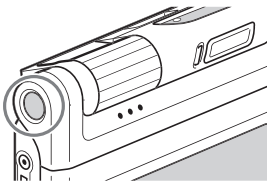

Press this button to take image files or movie files (for PEG-NX70V only) or to record sounds.

➔ For details, refer to “Enjoying your CLIÉ™ Handheld” on page 55.



## Camera (for PEG-NX70V only)

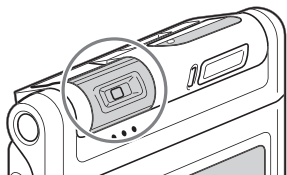

You can take image files or movie files.

### Note

When the camera is not used, rotate the lens part to the inward side of the CLIÉ handheld until it clicks into place.

► For details, refer to “Enjoying your CLIÉ Handheld” on page 55.

## REC LED

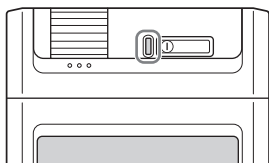

Lights when you are recording a movie.

► For details, refer to the explanation of each application in “CLIÉ Application Manual” on your computer.

## HOLD Switch

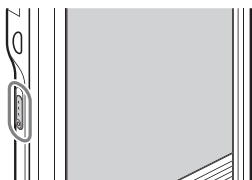

Protects your CLIÉ handheld from accidental tapping on the screen or pressure on the POWER button when you are carrying your CLIÉ handheld. If you slide this switch while the power is on, the screen display turns off, even during an operation.

### Note

When you cannot turn on or operate your CLIÉ handheld, check if the HOLD switch is not in the HOLD position.

If you try to turn on your CLIÉ handheld while the HOLD switch is in the HOLD position, the POWER LED indicator blinks green three times.

---

## BACK Button



Cancels the selection of an item and cancels the operation. Depending on the application, unique features such as restoring to the previous screen are assigned.

### Tip

Press the BACK button for a few seconds to switch to the CLIE Launcher screen.

- ➔ For details, refer to the explanation of each application in “CLIE Application Manual” on your computer.

---

## Scroll Button



Displays text and other information that extends beyond the area of the screen. Pushing the ▼ button scrolls down to display information below the current viewing area, and pushing the ▲ button scrolls up to display the information above the current viewing area. Depending on the application, unique features are assigned.

- ➔ For details, refer to the explanation of each application in “CLIE Application Manual” on your computer.

## “Memory Stick” Slot

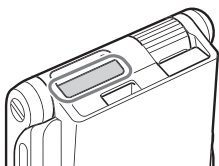

Insert a “Memory Stick” media into this slot.

The “Memory Stick” LED blinks in orange while your CLIÉ handheld is writing data to or reading data from a “Memory Stick” media.

► For details, refer to “Using “Memory Stick” media” in “Handbook.”

### Inserting a “Memory Stick” media

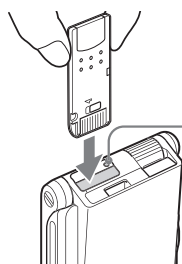

#### “Memory Stick” LED

The “Memory Stick” LED blinks in orange while your CLIÉ handheld is writing to or reading data from a “Memory Stick” media.

#### Notes

- Insert “Memory Stick” media in the right direction. If “Memory Stick” media is forcibly inserted in the wrong direction, the “Memory Stick” slot may be damaged.
- Do not insert a “Memory Stick” media other than the “Memory Stick” slot.

### Removing a “Memory Stick” media



Push the “Memory Stick” media in

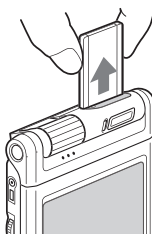

Pull the “Memory Stick” media out

#### Note

Make sure that your CLIÉ handheld is not writing to or reading data from a “Memory Stick” media (the “Memory Stick” LED is not blinking) before removing it. If you remove a “Memory Stick” media while the “Memory Stick” LED is blinking, recorded data may be deleted or damaged.

.....

## IR port

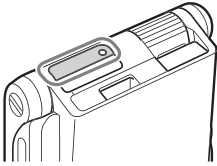

You can beam data between your CLIE handheld and another CLIE handheld or Palm OS® PDA.

➔ For details, refer to “Beaming” in “Handbook.”

### Tip

You can also use your CLIE handheld as a remote control with the CLIE Remote Commander software.

➔ For details, refer to “CLIE Application Manual” on your computer.

### Note

Be sure not to conceal the IR port with the display panel when your CLIE handheld is set to “opened style.”

# Hardware Keyboard

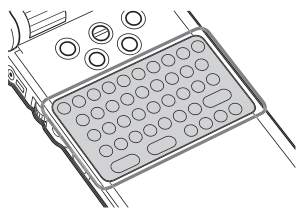

You can use the hardware keyboard in the same way as with the keyboard of your computer. It is convenient when you want to enter lots of data.

## Input commands list

You can carry out commands using the hardware keys in combination.

### Key combinations

Example: Ctrl+C → Hold down the Ctrl key and press the key of the character C.

Combination	Function
<b>Fn + character</b>	Enter the numbers and marks printed in blue.
<b>Shift + character</b>	Enter the alphabets in upper case when “Caps” is off.
<b>Shift + →/←</b>	Selects a continuing/preceding text.
<b>Shift + Ctrl + ←</b>	Selects until the first letter of the text.
<b>Shift + Ctrl + →</b>	Selects until the last letter of the text.
<b>Ctrl + C</b>	Copies the selected text.
<b>Ctrl + X</b>	Cuts the selected text.
<b>Ctrl + V</b>	Pastes the selected text.
<b>Ctrl + D</b>	Deletes the selected text.
<b>Ctrl + L</b>	Turns the backlight on and off.
<b>Ctrl + H</b>	Switches to the CLIE Launcher screen.
<b>Ctrl + M</b>	Displays the menu.
<b>Ctrl + F</b>	Opens the Find dialog box.
<b>Ctrl + ↑</b>	Same as rotating the Jog Dial™ navigator upwards.
<b>Ctrl + ↓</b>	Same as rotating the Jog Dial™ navigator downwards.
<b>Ctrl + ↵</b>	Same as pressing the Jog Dial™ navigator.
<b>Ctrl + ↵ and hold</b>	Same as keeping the Jog Dial™ navigator pressed.
<b>Ctrl + BS</b>	Same as pressing the BACK button.

*Continued on next page*

<b>Ctrl + BS and hold</b>	Same as keeping the BACK button pressed.
<b>Ctrl + Shift + ↑</b>	Same as rotating the Jog Dial™ navigator upwards while pressing it.
<b>Ctrl + Shift + ↓</b>	Same as rotating the Jog Dial™ navigator downwards while pressing it.
<b>Ctrl + Tab</b>	Jumps to the next field.
<b>Ctrl + Shift + Tab</b>	Jumps back to the previous field.

## ..... Wireless Communication Slot

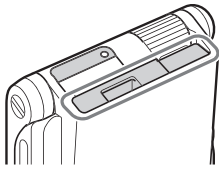

You can connect to the Internet, by using the compact flash type data network card (From this point referred to as network card).

➔ For details, refer to “Connecting to the Internet” (page 67).

### Operation confirmed network card

Wireless LAN card SONY PEGA-WL100

#### Notes

- Only the compact flash type data network card can be inserted into the wireless communication slot. Network cards or memory cards other than the above-mentioned will not work. Do not use any other card in your CLIÉ handheld, as it may cause a malfunction.
- If your CLIÉ handheld is not working properly, remove the network card once, and insert the network card again.
- There may be some data network services that may not be used, depending on the network card and provider that you are using. For details, refer to the operating instructions of your network card or contact your Internet service provider.

## Inserting the network card

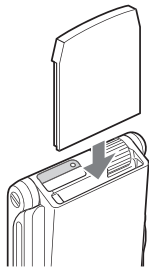

### Tip

The protect card is inserted into the wireless communication slot at the factory.

### Note

If the network card is forcibly inserted in the wrong direction or angle, the CLIÉ handheld may cause a malfunction.

## Removing the network card

Make sure that your CLIÉ handheld is turned off, and then pull out the network card.

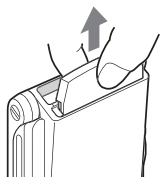

### Notes

- Do not remove the network card while it is connected to the Internet, as a malfunction may occur.
- When the wireless communication slot is empty, always insert the protect card to protect the slot.
- If the network card is forcibly removed from the wireless communication slot in the wrong direction or angle, the CLIÉ handheld or network card may cause a malfunction.

# Locating the components of the front panel

## Tip

If a different screen is displayed, tap “**3** Home icon.”

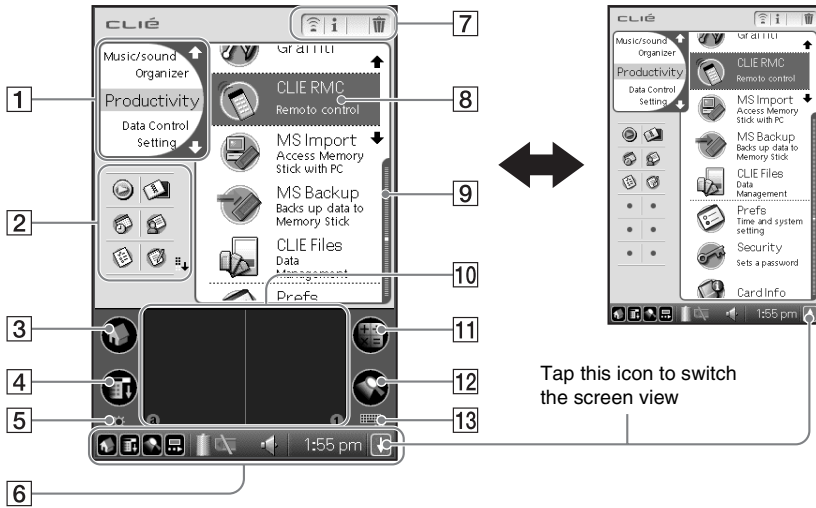

### **1** CLIE Launcher Groups List

The list of CLIE Launcher groups is displayed.

### **2** Favorite Applications (shortcuts)

You can create shortcuts to favorite applications.

### **3** Home Icon

If you tap this icon, the Application Launcher (List of applications) screen will be displayed.

### **4** Menu Icon

If you tap this icon, the menu of the current application will be displayed.

### **5** Brightness Adjustment Icon (page 41)

### **6** Status Bar (page 42)

### **7** Application Manager Icon (page 41)

### **8** Application Icon (page 44)

### **9** Position Indicator

### **10** Graffiti® Writing Area

This is the area for manually entering with Graffiti® characters.

### **11** Calculator (page 80)

If you tap this icon, the on-screen Calculator will be displayed.

### **12** Find Icon

If you tap this icon, the Find dialog box will be displayed.

### **13** Graffiti/Software Keyboard Icon (page 42)



## Brightness Adjustment Icon



Tap this icon to adjust the brightness level of the LCD screen of your CLIÉ handheld.

### Note

If the digitizer preferences are not set correctly, you may have difficulty in tapping.

- For details, refer to “Customizing your Sony CLIÉ Handheld: Adjusting the digitizer” in “Handbook.”

## Application Manager Icon



You can manage your applications with the application manager icons.

The followings are featured as standard functions.

-  : Beam
-  : Info
-  : Delete

- For details, refer to “Sony CLIÉ™ Handheld basic operations: Using “CLIE Launcher”: Application manager icon” in “Handbook.”

### Tip

Functions may be added when you install some applications.

## ..... Icons for switching the Graffiti/Software Keyboard



You can switch between the Graffiti writing area and the software keyboard by tapping this icon.

The working of the software keyboard is the same as the on-screen keyboard, however the applications can be used without minimizing the current screen.

### Tip

#### To switch the software keyboard display

You can switch the keyboard display by tapping the following icons:

**abc** : The alphanumeric keyboard

**int'l** : The international keyboard

**sym** : The symbol keyboard

## ..... Status Bar



Displays the following icons for all applications. Additional icons appear according to the applications in use.

 : Tap this icon to display the CLIE Launcher screen.

 : Tap this icon to display the menus of the current application.



 : Tap this icon to open the Find dialog box.

 : Tap this icon to display the Silk Plug-In screen.

If the Silk Plug-In is installed, you can edit the display and functions of the Silk Screen area by switching the Silk Plug-In.





Silk Screen area

 : Displays the battery's remaining charge. The  icon is displayed during the battery charge.

 : Tap this icon to display the information for the “Memory Stick” media inserted in your CLIÉ handheld.

When the Data Protection switch of the “Memory Stick” media is at the “Lock” position, the  icon is displayed.

When you insert a “Memory Stick”-type accessory in your CLIÉ handheld, the  icon is displayed.

When the “Memory Stick” media cannot be read normally, the  icon is displayed.

When the “Memory Stick” slot of your CLIÉ handheld is empty, the  icon is displayed.

 : Tap this icon to display the **Adjust Volume** screen.

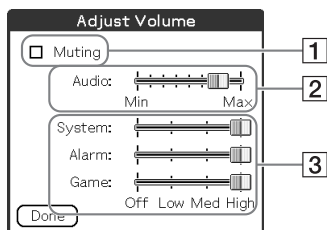

- 1 Turns off the sound of your CLIÉ handheld irrespective of the volume level setting. While the Muting mode is selected, the  icon is displayed in the status bar.
- 2 Adjusts the volume level for playback sound of audio files or movie files.
- 3 Adjusts the volume level for System sound, Alarm sound, or Game sound. The setting affects the **General Preference**.  
➤ For details, refer to “Customizing your Sony CLIÉ handheld: Setting sounds” in “Handbook.”

 : Displays the current time. To change the display format, tap the **Time** in the **Formats Preference**.

➤ For details, refer to “Customizing your Sony CLIÉ handheld: Setting the Date & Time preferences” in “Handbook.”

 : Tap this icon to show or hide the Graffiti writing area (for Graffiti compatible applications only).

# Using applications

Your CLIE handheld can carry out various functions through applications. You need to start an application when you utilize certain features or functions.

## ..... Tapping the desired application icon in the CLIE Launcher screen

- 1 Tap the Home  icon to display the CLIE Launcher screen.
- 2 Rotate the Jog Dial™ navigator to select an application icon and press it to start.

**Tip**

You can also tap the desired application icon in the CLIE Launcher screen to start the application.



- ➔ For details, refer to “Sony CLIE™ Handheld basic operations: Starting an application” or “Sony CLIE™ Handheld basic operations: Using “CLIE Launcher”” in “Handbook.”

## Pressing the application button

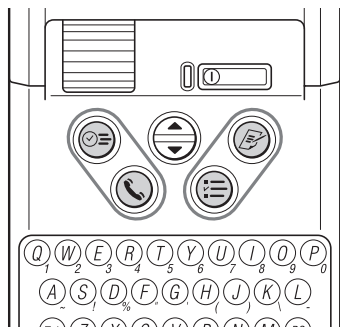

You can press the application button to start an application when your CLIE handheld is set to the opened style. At the factory setting, the application buttons are set to start Date Book, Address, To Do List, and Memo Pad as icons shown on each button.

### Tips

- Even when your CLIE handheld is turned off, pressing an application button turns on your CLIE handheld to start an application.
- You can assign your desired application to each application button.
- For details, refer to “Customizing your Sony CLIE handheld: Assigning applications to application buttons” in “Handbook.”

## Quitting an application and opening another application

You can only operate one application at a time in your CLIE handheld. When you start another application, the previous application automatically closes, therefore **you do not need to “Quit an application.”**

To open an application when another application has been already started, tap the Home  icon or press the application button.

### Tip

The operation to save data is not required when you quit an application. All the changes in the application that you are working on are automatically saved.

### Note

For some applications, you need to operate **Finish** or **Save**.



- For details, refer to “CLIE Application Manual” on your computer.

# Opening/Playing back files (CLIE Viewer)

You can use “CLIE Viewer” to view image files and movie files on your CLIE handheld and to open voice memo or handwriting memos.

➔ For details, refer to “CLIE Application Manual” on your computer.

## Opening/Playing back files

- 1 Tap the Home  icon to display the CLIE Launcher screen.
- 2 Select the CLIE Viewer  icon to start CLIE Viewer.



- 3 Rotate the Jog Dial™ navigator to select the file you want to display and press the Jog Dial™ navigator.  
The selected file is displayed.

### Tip

You can also display the file by tapping the file icon.

The files are listed in the order of creation date and time.



# Selecting/Deleting files in CLIE Viewer

You can select the file from the list screen in CLIE Viewer when attaching image files or movie files of your CLIE handheld to your e-mails, when using the image files in PhotoStand (page 73), CLIE Album (page 72) and Photo Editor (page 73), or when deleting files.

## 1 Start CLIE Viewer and tap the command button to select the function.

 : Select the file to be attached to the e-mail

The icon will be displayed if the CLIE Mail application is installed.

 : Select the image file to be used in PhotoStand

 : Select the file to be deleted

 : Select other applications such as Photo Editor or CLIE Album by using the pull-down menu



## 2 Tap to select the check box of the file.

### Tip

Tap **Select All** to select all the files.

## 3 Tap OK.

The function selected in step 1 is executed.

# Entering data

.....

## Entering data

There are five ways to enter data in your CLIÉ handheld. Select the one that best suits you.

### ● **Hardware keyboard (page 37)**

You can enter data using the hardware keyboard in the same way as with the keyboard of your computer. It is convenient when you want to enter lots of data.

### ● **On-screen keyboard**

You can enter data by tapping the keyboard that appears on the screen.

➔ For details on entering data using the on-screen keyboard, refer to “Entering data in your Sony CLIÉ™ Handheld: Practicing entering data using the on-screen keyboard” in “Handbook.”

### ● **Software keyboard (page 42)**

The working of the software keyboard is the same as the on-screen keyboard, however the applications can be used without minimizing the current screen.

### ● **Graffiti®**

You can enter data using an exclusive input system called Graffiti®. Once you get used to writing with Graffiti®, you will find that it is much faster than using the on-screen keyboard.

➔ For details on using Graffiti, refer to “Entering data in your Sony CLIÉ™ Handheld: Using Graffiti® writing to enter data” in “Handbook.”

### ● **HotSync with a computer**

You can enter data using your computer keyboard with a HotSync® operation. Text data are transferred from your computer to your CLIÉ handheld by a HotSync® operation using the Palm™ Desktop for CLIÉ software. For details, refer to the Help menu in the Palm™ Desktop for CLIÉ software.



# Exchanging and updating data using a HotSync<sup>®</sup> operation

## What is a HotSync<sup>®</sup> operation?

A HotSync<sup>®</sup> operation is a one-step operation that allows you to synchronize data between your CLIÉ handheld and your computer, back up the data of your CLIÉ handheld on your computer, or install add-on applications.

- For details, see “Exchanging and updating data using a HotSync<sup>®</sup> operation” in “Handbook.”

## Performing a HotSync<sup>®</sup> operation

In this example, you connect your CLIÉ handheld to computer and synchronize data with the Palm<sup>™</sup> Desktop for CLIÉ software data on your computer using Date Book.

- 1** Turn on the computer and start Windows<sup>®</sup> operating system.
- 2** Refer to the procedures on page 62 and enter data in the Date Book.
- 3** Place your CLIÉ handheld on the cradle.

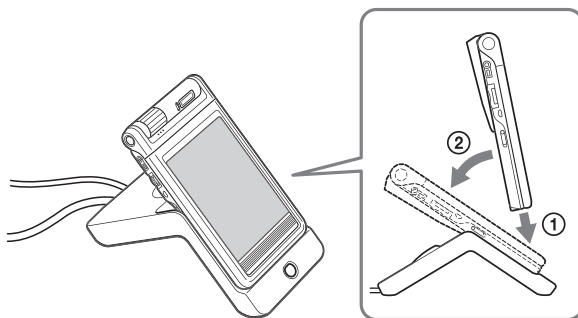

**4** Press the HotSync  button on the cradle.

The HotSync operation between your CLIÉ handheld and computer starts.

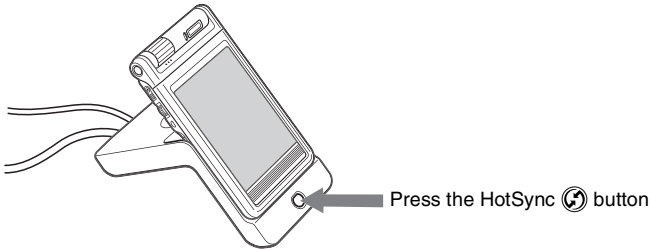

When the HotSync<sup>®</sup> operation is complete, the following screen is displayed.

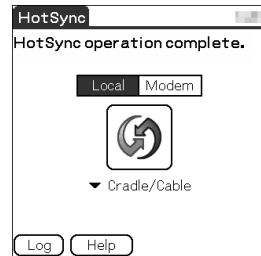

**5** Double-click the Palm™ Desktop for CLIÉ software icon on the Windows desktop.

Or click **Start**, select **Programs (All Programs in Windows XP), Sony Handheld**, and click **Palm Desktop for CLIÉ**.

The Palm™ Desktop for CLIÉ software starts.

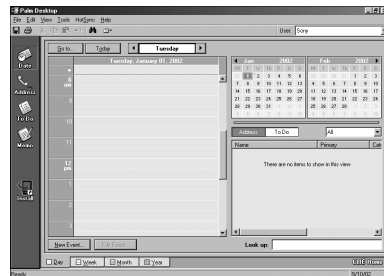

## 6 Click the Date Book icon.

The Date Book window is displayed.

The detail of the schedule for the selected date in Step 2 will be displayed.

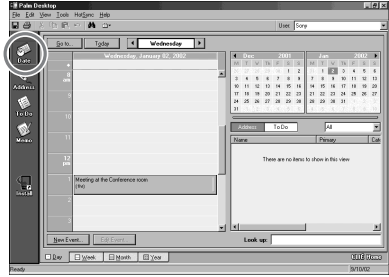

# Resetting your Sony CLIÉ Handheld

Under normal circumstances, you do not have to reset your CLIÉ handheld. On rare occasions, however, your CLIÉ handheld may no longer respond to buttons or commands due to insufficient memory or other reasons.

In this case, you need to perform a reset to get your CLIÉ handheld running again.

.....

## Performing a soft reset

All records and entries stored in your CLIÉ handheld are retained even after performing a soft reset.

- 1 Take out the stylus pin by unscrewing the metal barrel from the stylus quill.

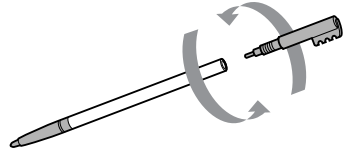

- 2 Use the stylus pin to gently press the reset button inside the hole on the back panel of your CLIÉ handheld.

The system shuts down and then restarts. After restarting, the system displays “palm powered,” “CLIÉ,” and “SONY,” followed by the Preferences screen for setting the time and date.

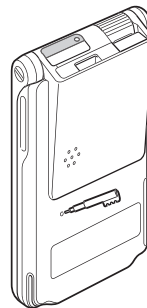

### Notes

- Do not press the reset button again, until the “Preferences” screen is displayed.
- Always press the reset button with the stylus pin, as malfunction may occur.

## Performing a hard reset

If the soft reset does not solve the problem, you need to perform a hard reset to restart your CLIÉ handheld.

### Notes

- With a hard reset, all records and add-on applications stored in your CLIÉ handheld are erased.
- Perform a hard reset only if a soft reset does not solve your problem.  
You can restore your CLIÉ handheld data if you have made a back-up on your computer or “Memory Stick” media.

- 1** Press the POWER button.
- 2** While holding down the POWER button, use the stylus pin to gently press and release the reset button.

Use the stylus pin to press the reset button as illustrated on page 52

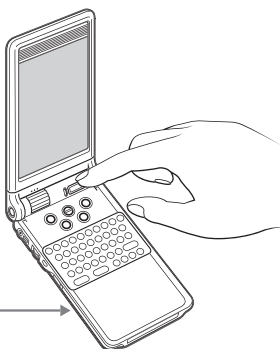

- 3** If the palm powered screen is displayed, release the POWER button after three seconds.  
A message warning that you are about to erase all the data stored on your CLIÉ handheld is displayed.

- 4 Press the ▲ button on the keyboard panel of your CLIÉ handheld.

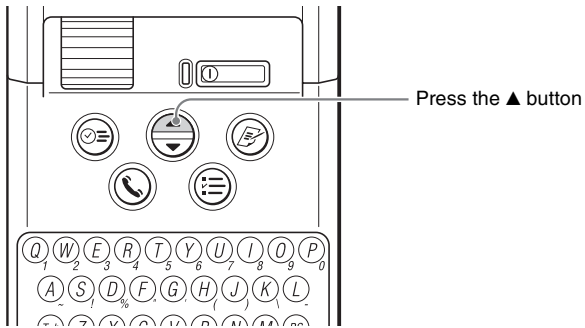

A hard reset is performed on your CLIÉ handheld.

After restarting, the system displays “palm powered,” “CLIÉ,” and “SONY,” followed by the digitizer calibration screen and then by the Preferences screen for setting the time and date. Refer to “Performing the initial settings” on page 22.

After a hard reset, only the current date and time are retained. Formats, Preferences, and other settings are restored to the factory settings.

#### Notes

- Do not press the reset button again, until the “Initial settings” screen is displayed.
- If the scroll button is not pressed for long enough, the hard-reset may not be performed.

# Enjoying your CLIE™ *Handheld*

## Enjoying image files

### ..... Taking images (for PEG-NX70V only)

- 1 Press the CAPTURE/REC button to start “CLIE Camera.”

**Tip**

You can also tap the CLIE Camera  icon in “CLIE Launcher”(page 44) to start “CLIE Camera.”

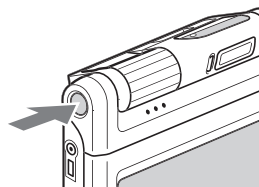

- 2 Point the built-in camera directly at the subject.

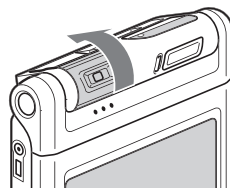

- 3 Capture the subject in the viewfinder and press the CAPTURE/REC button.  
A picture is taken.



.....

## Viewing image files

You can view image files in “CLIE Viewer.”

➔ For details, refer to “Opening/Playing back files (CLIE Viewer)” (page 46).

**Tip**

You can also start “CLIE Viewer” from the  icon on “CLIE Camera” screen.

.....

## Enjoying image files

### Preparing



#### Taking images

CLIE Camera.....page 71

#### Importing image files from your computer

Image Converter.....page 71



### Viewing/Selecting



#### Viewing/Selecting image files by searching from the list

CLIE Viewer.....page 72



### Utilizing features



#### Managing image files in albums

CLIE Album.....page 72



#### Displaying image files automatically

PhotoStand.....page 73



#### Editing image files

Photo Editor.....page 73



#### Attaching image files to the address

Address.....page 77



#### Sending image files by e-mail

CLIE Mail.....page 80



#### Transferring image files to your computer

Memory Stick Import.....page 83



# Enjoying movies

## Note

A "Memory Stick" media is required to take and view movies.

## Taking movies (for PEG-NX70V only)

- 1 Insert the "Memory Stick" media that you will use to save movie files.

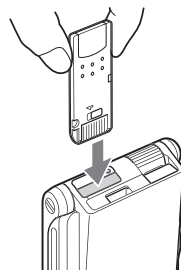

- 2 Select Movie Rec  icon in "CLIE Launcher" (page 44) and start it.



- 3 Point the built-in camera directly at the subject.

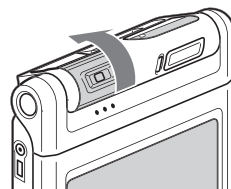

- 4 Capture the subject in the viewfinder and press the CAPTURE/REC button.  
Start recording the movie.

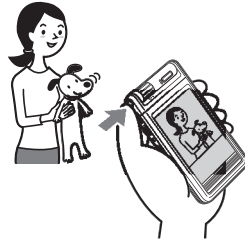

- 5 Press the CAPTURE/REC button once again when you have finished recording the movie.

.....

## Viewing movies

You can view movies in “CLIE Viewer.”

➔ For details, refer to “Opening/Playing back files (CLIE Viewer)” (page 46).

.....

## Enjoying movies

### Preparing



#### Taking movies

Movie Recorder..... page 74

#### Importing image/movie files from your computer

Image Converter..... page 71



### Viewing/Selecting



#### Viewing/Playing back a file after searching from the list

CLIE Viewer..... page 72



#### Playing back movies

Movie Player..... page 75



### Sending



#### Sending and receiving e-mail messages

CLIE Mail..... page 80

# Viewing image files and movie files taken with “Memory Stick” compliant devices on your CLIE handheld

## Tip

The following are file format that can be viewed on the CLIE handheld.

**Image files:** JPEG (DCF) format, PictureGear Pocket format

**Movie files:** Movie Player format (movie formats shot with your CLIE handheld or converted using the Image Converter software), MPEG Movie format (MPEG1 format movie files shot with a Sony Digital Still Camera or Handycam)

For formats of pictures that can be taken in your “Memory Stick” compliant devices, refer to their respective operating instructions.

- 1** Insert the “Memory Stick” media to which you have saved the image files and movie files in your CLIE handheld.

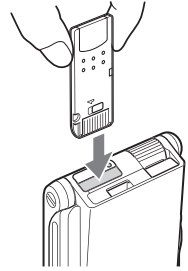

- 2** Start “CLIE Viewer” to view image files or movie files.
  - ➔ For details on how to use the CLIE Viewer, refer to “Opening/Playing back files (CLIE Viewer)” (page 46).

# Using voice recorder

## Recording a voice memo

- 1 Select Voice Rec  icon in “CLIE Launcher” (page 44) and start it.

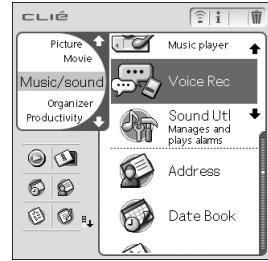

- 2 Press the CAPTURE/REC button (for PEG-NX70V) or the VOICE REC button (for PEG-NX60).  
The recording starts. Speak into the built-in microphone.

**Tip**

For PEG-NX60, press the VOICE REC button (page 32) to start “Voice Recorder” and recording.



- 3 Press the button once again to stop the recording.

## Playing back a voice memo

The voice memo can be played back with “Voice Recorder” or “CLIE Viewer.”

- For details about CLIE viewer, refer to “Opening/Playing back files (CLIE Viewer)” (page 46).
- For details about Voice Recorder, refer to “Voice Recorder” in “CLIE Application Manual” on your computer.

# Listening to music

## Note

You need to perform the following steps to listen to music on your CLIÉ handheld.

- 1 Transfer your personal music that you want to play back, from your computer to your CLIÉ handheld.  
➔ For details, refer to “Music” in “CLIÉ Application Manual” on your computer.
- 2 Connect the supplied remote control and headphones to the CLIÉ handheld.

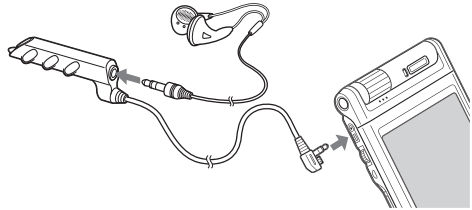

- 3 Select the AudioPlayer  icon on “CLIÉ Launcher” (page 44) and start it.

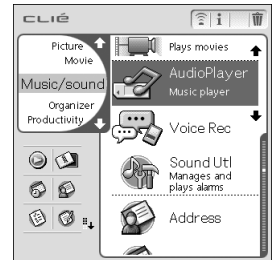

- 4 Tap the playback  button to play back music.  
Tap the stop  button to stop the music.



Playback button

Stop button

## Tip

You can also use the remote control.

# Managing schedules (Date Book)

## ..... Entering a schedule

**1** Press the  button to start the "Date Book."

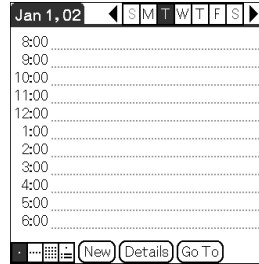

**2** Tap **New** and set the start time and end time of the schedule.

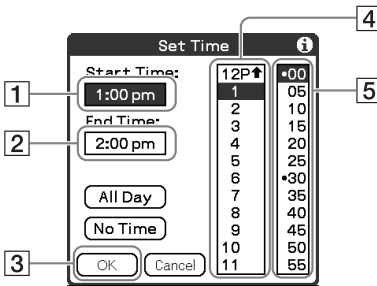

- 1** Tap to set the start time.
- 2** Tap to set the end time.
- 3** Tap to determine the settings.
- 4** Tap to select "hour."
- 5** Tap to select "minute."

**3** Enter the schedule.

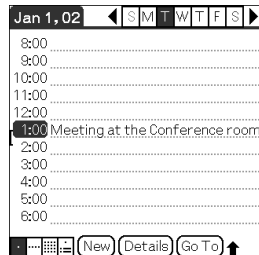

.....

## Deleting a schedule

- 1 Tap the schedule you want to delete and tap the Menu  icon from the Date Book list screen.
- 2 Tap **Delete Event...** from the **Record** menu.  
The confirmation message is displayed.

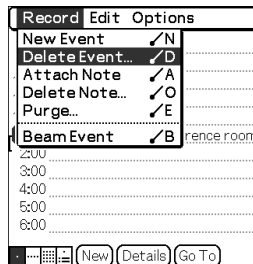

- 3 Tap OK.

# Managing addresses and telephone numbers (Address)

## Entering a new address

- 1 Press the  button to start "Address".
- 2 Tap **New** and enter the details.

### Tip

You can scroll the screen by tapping the ▲/▼ arrow at the bottom right.

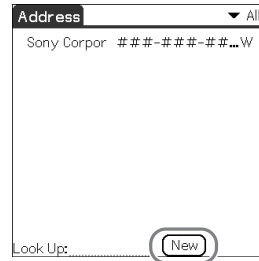

## Deleting an address entry

- 1 Tap the address you want to delete and tap the Menu  icon.
- 2 Tap **Delete Address...** from the **Record** menu.  
The confirmation message is displayed.

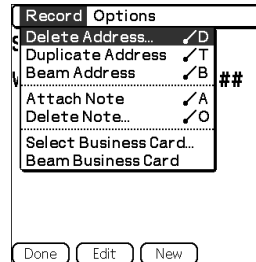

- 3 Tap **OK**.



# Exchanging the Date Book and Address data between your CLIÉ handheld and computer

HotSync® operation (page 49) enables you to exchange the Date Book data or the Address data between your CLIÉ handheld and computer.

Depending on the applications that you are using in your computer, there are two ways to exchange data.

## Exchanging data between your CLIÉ handheld and Palm™ Desktop for CLIÉ software in your computer

Synchronize the Date Book and Address managed by the Palm™ Desktop for CLIÉ software in your computer to the CLIÉ handheld.

- For details on connecting with the Palm™ Desktop for CLIÉ software, refer to “Exchanging and updating data using a HotSync® operation” (page 49).

## Exchanging data between your CLIÉ handheld and Microsoft® Outlook (Intellisync® Lite) in your computer

“Intellisync Lite” must be installed in your computer to connect with Microsoft® Outlook and Lotus Organizer.

- For details on how to install, refer to “Installing the Palm™ Desktop for CLIÉ software on your computer” (page 19).

### Tip

Intellisync Lite can be installed from “Using your CLIÉ Handheld” of the installer menu screen.

- For details on how to start and set-up, refer to the help of “Intellisync Lite.” To view help, click **Programs** (In case of Windows XP, click **All Programs**) from the **Start** menu, then click **Intellisync Lite** and **Intellisync Help**.

# Viewing Microsoft® Word and Microsoft® Excel documents on your CLIÉ handheld (Documents To Go®)

## Note

Perform the following steps before using “Documents To Go” software.

- 1 Install “Documents To Go” in your computer and CLIÉ handheld.
- 2 Transfer documents from your computer to your CLIÉ handheld.



- 3 Start “Documents To Go” on your CLIÉ handheld and view the documents transferred from your computer.

## Tip

You can also edit the documents in your CLIÉ handheld and transfer to your computer.

- ➔ For details, refer to the help of “Documents To Go.”

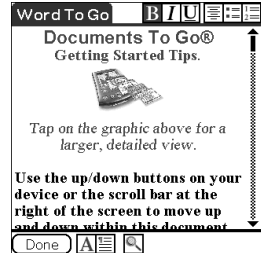

# Connecting to the Internet

## Note

For an internet connection, you must have a network card that is compliant with your CLIÉ handheld and a service of Internet service provider. Contact your Internet service provider to confirm compatibility.

## Installing applications in your CLIÉ handheld

Install the applications in your CLIÉ handheld for your purposes.

**Browsing websites in your CLIÉ handheld:** NetFront (page 81)

**Exchanging e-mail:** CLIE Mail (page 80)

➤ For details about the necessary set-up of each application, refer to “CLIÉ Application Manual” on your computer.

## Setting up a network card

Set up a network card, such as “Wireless LAN card PEGA-WL100”.

## Tip

For details on how to set up a network card, refer to the manual of each network card.

## Connecting to the Internet

- 1 Insert the network card in your CLIÉ handheld.
- 2 Select the desired application in “CLIE Launcher” (page 44) and start it.
- 3 Start browsing websites, sending or receiving e-mail. Internet connection starts automatically.

## Tip

When you want to attach image files or movie files from your CLIÉ handheld to your e-mail, you can select those files from the list displayed in “CLIE Viewer”.

➤ For details, refer to “Selecting/Deleting files in CLIE Viewer” (page 47).

# Using applications

This chapter describes how to use add-on applications and “CLIÉ Application Manual.” For details about add-on applications, refer to the manuals that come with each add-on application.

## About add-on applications

Applications are divided into three types as follows:

- **Applications already installed on your CLIÉ handheld**
- **Applications you need to install on your CLIÉ handheld**

For details about using the Installation CD-ROM, follow the procedure on page 70.

- **Applications you need to install on your computer**

## Using CLIÉ Application Manual

For details about using the add-on applications, refer to “CLIÉ Application Manual” on your computer.

### Notes



- Prior to using applications, refer to “Installing the Palm™ Desktop for CLIÉ software on your computer” on page 19 to install the Palm™ Desktop for CLIÉ software. CLIÉ Application Manual will be installed at the same time.
- CLIÉ Application Manual requires Microsoft Internet Explorer Version 5.0 or later to be displayed properly.

.....

## Opening CLIÉ Application Manual

- 1** Double click the CLIÉ info icon on the Windows desktop. “CLIÉ info” window is displayed.
- 2** Select the manual by following the on-screen instructions.

### Tips

- To close CLIÉ Application Manual, click the  icon in the top right corner in the CLIÉ Application Manual window.
- You can minimize the CLIÉ Application Manual window by clicking  icon in the top right corner in the window. The minimized window can be reopened by clicking the CLIÉ Application Manual button in the task bar.
- You can operate other software while the CLIÉ Application Manual window is displayed on the Windows desktop.

# Installing add-on applications on your CLIÉ handheld

You can install applications with the supplied Installation CD-ROM by following the steps below.

Prior to installing applications, install the Palm™ Desktop for CLIÉ software on your computer with the supplied Installation CD-ROM and connect the cradle to your computer.

## Note

The add-on applications are designed to operate on PEG-NX70V/NX60 only. Compatibilities with other CLIÉ handheld or Palm OS PDAs are not guaranteed.

- 1** Quit all applications running on Windows® operating system.
- 2** Insert the Installation CD-ROM into the CD-ROM drive of your computer.  
The installation launcher window appears.
- 3** Click CLIÉ Desktop.
- 4** Click "Install" to the right of CLIÉ Add-ons.
- 5** Select the add-on applications to install.
- 6** Click Next.
- 7** Select the User.
- 8** Click OK.
- 9** Click Done.
- 10** To install the application on your CLIÉ handheld, press the HotSync button on the cradle.

# Introducing add-on applications

## Taking images (for PEG-NX70V only)

- Application to be used  
**CLIE Camera** **CLIE Handheld**



- Keyword**  
JPEG (DCF) format

- Summary**  
For taking images using the built-in camera of the CLIE handheld.



- Preparation for use**  
**Installed**

➔ For details, refer to “CLIE Application Manual” on your computer.

## Importing image/movie files from your computer

- Application to be used  
**Image Converter** **PC**

- Keyword**  
JPEG (DCF) format, Movie Player format

- Summary**  
For converting the formats of pictures in your computer so that they can be viewed on your CLIE handheld.

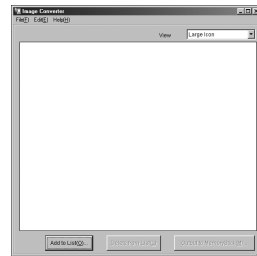

- Preparation for use**  
**Must be installed** **Requires “Memory Stick”**

- Installation CD-ROM Menu**  
“CLIE Image”

➔ For details, refer to “CLIE Application Manual” on your computer.

.....

## Viewing/Playing back a file after searching from the list

■ **Application to be used**

 **CLIE Viewer** CLIE Handheld

■ **Summary**

For managing and displaying image files, movie files, handwriting memos and Voice memo files.



■ **Preparation for use**

Installed

➔ For details, refer to “CLIE Application Manual” on your computer.

.....

## Managing image files in albums

■ **Application to be used**

 **CLIE Album** CLIE Handheld

■ **Summary**

For managing image files saved in your CLIE handheld or “Memory Stick” media, in an album format.

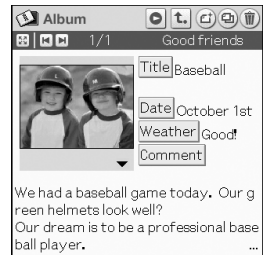

■ **Preparation for use**

Installed

➔ For details, refer to “CLIE Application Manual” on your computer.



## Displaying image files automatically

Application to be used  
 **PhotoStand** CLIÉ Handheld

Keyword  
JPEG (DCF) format

Summary  
For displaying automatically image files one after the other.

Preparation for use  
**Installed**



➔ For details, refer to “CLIÉ Application Manual” on your computer.

## Editing images

Application to be used  
 **Photo Editor** CLIÉ Handheld

Keyword  
JPEG (DCF) format

Summary  
For drawing pictures on an image file saved in your CLIÉ handheld. You can also draw pictures on a new blank canvas.

Preparation for use  
**Installed**



➔ For details, refer to “CLIÉ Application Manual” on your computer.

# Importing image files from your CLIÉ handheld to your computer

## Application to be used PictureGear Studio **PC**

### Summary

For importing image files from your CLIÉ handheld to your computer and managing the image files.

- Creates albums or binders for image files
- Imports image files to the computer and manages the image files
- Prints out labels
- Exchanges data created using the CLIÉ Album application between your CLIÉ handheld and computer.



### Preparation for use

**Must be installed** Requires "Memory Stick"

### Installation CD-ROM Menu

"CLIÉ Image"

➔ For details, refer to "CLIÉ Application Manual" on your computer.

# Taking movies (for PEG-NX70V only)

## Application to be used Movie Recorder **CLIÉ Handheld**

### Keyword

Movie Player format (movie formats shot with your CLIÉ handheld or converted using the Image Converter software)

### Summary

For taking movies using the built-in camera of the CLIÉ handheld.

### Preparation for use

**Installed** Requires "Memory Stick"



[www.aibo.com](http://www.aibo.com)

➔ For details, refer to "CLIÉ Application Manual" on your computer.

## Playing back movies

### Application to be used



**Movie Player** CLIÉ Handheld

### Keyword

Movie Player format (movie formats shot with your CLIÉ handheld or converted using the Image Converter software), MPEG Movie format (MPEG1 format movie files shot with a Sony Digital Still Camera or Handycam), Play List, Repeat function, Index function



www.aibo.com

### Summary

For playing back movies recorded with the built-in camera of the CLIÉ handheld (for PEG-NX70V only) or playing back movies in your CLIÉ handheld using “Image Converter” software of your computer.

### Preparation for use

Installed

Requires “Memory Stick”

➔ For details, refer to “CLIÉ Application Manual” on your computer.

## Playing back Macromedia® Flash™

### Application to be used



**Macromedia Flash Player 5**

CLIÉ Handheld

### Keyword

swf format

### Summary

For playing back the Macromedia Flash contents.

Some Flash contents for computers may not be played back normally on your CLIÉ handheld.



### Preparation for use

Installed

Requires “Memory Stick”

➔ For details, refer to “CLIÉ Application Manual” on your computer.

# ..... Listening to music with your CLIÉ handheld

## Application to be used



## Keyword

MP3, ATRAC3

## Summary

For playing back music files saved in a “Memory Stick” media.



## Preparation for use

Installed

Needs to be connected to your computer

Requires “Memory Stick”

➔ For details, refer to “CLIÉ Application Manual” on your computer.

# ..... Transferring music files to your CLIÉ handheld

## Application to be used

SonicStage 1.5 PC

## Keyword

ATRAC3

## Summary

For managing and creating music files to be played back with your CLIÉ handheld in your computer.

The application is also used for transferring music files to a “Memory Stick” media.

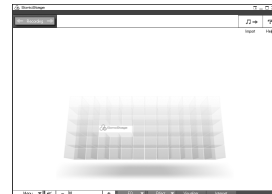

## Preparation for use

Must be installed

## Installation CD-ROM Menu

“CLIÉ Audio”

➔ For details, refer to “CLIÉ Application Manual” and “SonicStage Help” on your computer.

## Recording voice memo

### Application to be used



**Voice Recorder** CLIÉ Handheld

### Summary

For recording and playing back a voice memo using the built-in microphone of your CLIÉ handheld.

### Preparation for use

Installed



➔ For details, refer to “CLIÉ Application Manual” on your computer.

## Managing addresses and telephone numbers

### Application to be used



**Address** CLIÉ Handheld

### Summary

For entering and editing Address information such as names, addresses or telephone numbers.

### Preparation for use

Installed

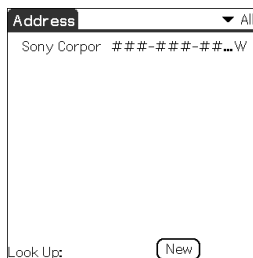

➔ For details, refer to “CLIÉ Application Manual” on your computer.

.....

## Managing schedules and events

■ **Application to be used**



**Date Book** CLIÉ Handheld

■ **Summary**

For managing schedules and events such as meetings or business trips.

■ **Preparation for use**

Installed

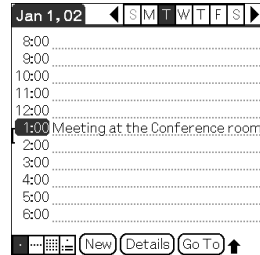

➔ For details, refer to “CLIÉ Application Manual” on your computer.

.....

## Managing tasks and things to do

■ **Application to be used**



**To Do List** CLIÉ Handheld

■ **Summary**

For displaying tasks that you want to be reminded of later. You can assign priority to any task.

■ **Preparation for use**

Installed

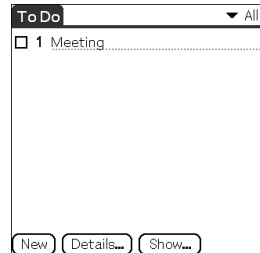

➔ For details, refer to “CLIÉ Application Manual” on your computer.

## Taking memos

### Application to be used



**Memo Pad** CLIÉ Handheld

### Summary

For taking memos or displaying documents created in your computer.

### Preparation for use

Installed

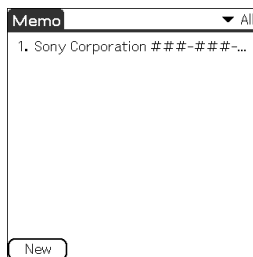

➔ For details, refer to “CLIÉ Application Manual” on your computer.

## Taking handwriting memos using the stylus

### Application to be used



**CLIÉ Memo** CLIÉ Handheld

### Summary

For taking handwriting memos using the stylus.

### Preparation for use

Installed

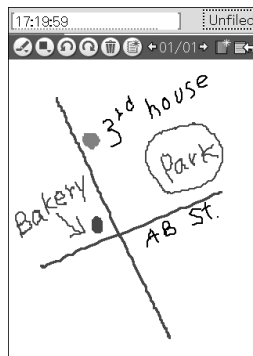

➔ For details, refer to “CLIÉ Application Manual” on your computer.

.....

## Using the calculator

■ **Application to be used**



**Calculator** CLIÉ Handheld

■ **Summary**

For calculating with your CLIÉ handheld. You can save and recall calculations with the calculator's memory.

■ **Preparation for use**

**Installed**

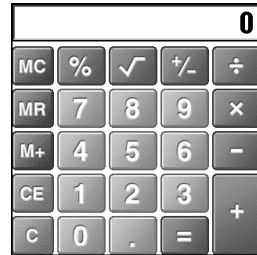

➔ For details, refer to “CLIÉ Application Manual” on your computer.

.....

## Sending and receiving e-mail messages

■ **Application to be used**



**CLIÉ Mail** CLIÉ Handheld

■ **Summary**

For sending and receiving e-mail messages in your CLIÉ handheld.

■ **Preparation for use**

**Must be installed**

■ **Installation CD-ROM Menu**

“CLIÉ Desktop” – “CLIÉ Add-ons”

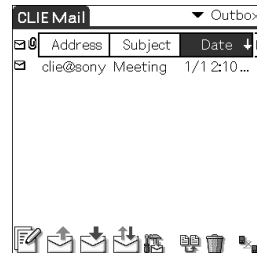

➔ For details, refer to “CLIÉ Application Manual” on your computer.



## Browsing websites

Application to be used  
 **NetFront** **CLIÉ Handheld**

Keyword  
Websites, Internet, WWW browser

Summary  
For browsing websites with your CLIÉ handheld.

Preparation for use  
**Must be installed**

Installation CD-ROM Menu  
“CLIÉ Desktop” – “CLIÉ Add-ons”

➔ For details, refer to “CLIÉ Application Manual” on your computer.

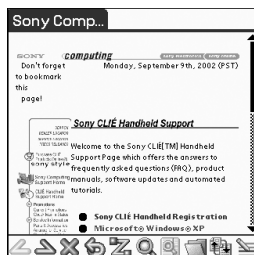

## Using as a remote control

Application to be used  
 **CLIÉ Remote Commander**  
**CLIÉ Handheld**

Keyword  
Beaming

Summary  
For using your CLIÉ handheld as a remote control.

Preparation for use  
**Installed**



Using applications

➔ For details, refer to “CLIÉ Application Manual” on your computer.

## Displaying the worldwide local time

### Application to be used



#### World Alarm Clock

CLIÉ Handheld

### Summary

For displaying the worldwide local time. You can also use the application as an alarm clock.

### Preparation for use

Must be installed

### Installation CD-ROM Menu

“CLIÉ Desktop” – “CLIÉ Add-ons”

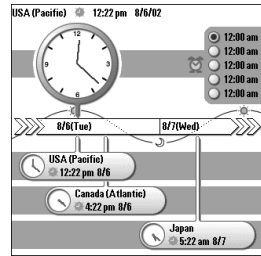

➔ For details, refer to “CLIÉ Application Manual” on your computer.

## Exchanging data between your CLIÉ handheld and “Memory Stick” media

### Application to be used



#### CLIÉ Files

CLIÉ Handheld

### Summary

For exchanging data (copy, move, delete) between the CLIÉ handheld and your “Memory Stick” media inserted in the CLIÉ handheld or for exchanging data within a “Memory Stick” media.

### Preparation for use

Installed

Requires “Memory Stick”

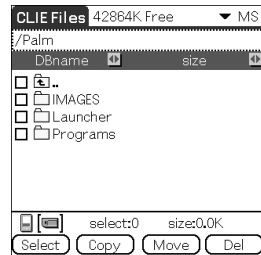

➔ For details, refer to “CLIÉ Application Manual” on your computer.

## Making a back up in a “Memory Stick” media

### Application to be used Memory Stick Backup



CLIÉ Handheld

### Summary

For making a backup of the application or data in a “Memory Stick” media.

### Preparation for use

Installed

Requires “Memory Stick”

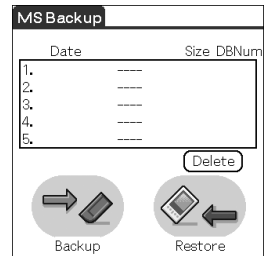

➔ For details, refer to “CLIÉ Application Manual” on your computer.

## Using the “Memory Stick” in the CLIÉ handheld on the computer

### Application to be used Memory Stick Import



CLIÉ Handheld

Memory Stick Export PC

### Summary

For installing application or copying data from your computer to a “Memory Stick” media in your CLIÉ handheld without using a HotSync® operation.

### Preparation for use

Requires “Memory Stick”

Memory Stick Import Installed

Memory Stick Export **Must be installed**

### Installation CD-ROM Menu

“CLIÉ Utilities”

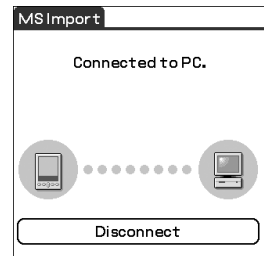

➔ For details, refer to “CLIÉ Application Manual” on your computer.

## Customizing the sound settings

### Application to be used



**Sound Utility** CLIÉ handheld

### Summary

For managing the audio data converted with Sound Converter 2. The audio data files are transferred from your computer to your CLIÉ handheld via a HotSync® operation.

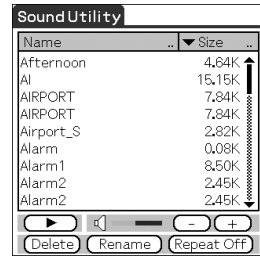

### Preparation for use

**Installed**

**Needs to be connected to your computer**

➔ For details, refer to “CLIÉ Application Manual” on your computer.

## Sending audio data to your CLIÉ handheld

### Application to be used

**Sound Converter 2** PC

### Keyword

WAVE (PCM) format, MIDI (Standard MIDI File Format 0/1) format

### Summary

For converting the audio data of WAVE (PCM) format or MIDI format in your computer to audio data of the CLIÉ handheld format.

### Preparation for use

**Must be installed**

### Installation CD-ROM Menu

“CLIÉ Utilities”

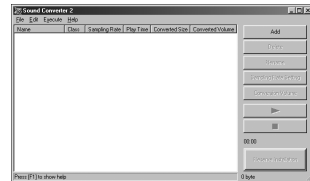

➔ For details, refer to “CLIÉ Application Manual” on your computer.

## Using Microsoft® Word/Excel data

### Application to be used



**Documents To Go**

CLIÉ handheld PC

### Keyword

doc format, xls format, txt format

### Summary

For opening or editing Microsoft Word/Excel data in your CLIÉ handheld.

### Preparation for use

**Must be installed** Needs to be connected to your computer

### Installation CD-ROM Menu

“CLIÉ Utilities”

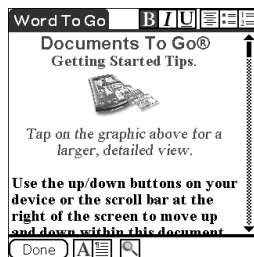

➔ For details, refer to “CLIÉ Application Manual” and “Documents To Go Help” on your computer.

## Exchanging data with Microsoft® Outlook

### Application to be used

**Intellisync Lite** PC

### Summary

For exchanging the data between Microsoft Outlook/Lotus Organizer and Date Book, Address, To Do, etc., of the CLIÉ handheld.

### Preparation for use

**Must be installed** Needs to be connected to your computer

### Installation CD-ROM Menu

Select **Palm Desktop for CLIÉ** from **CLIÉ Desktop**, and follow the on-screen instructions.

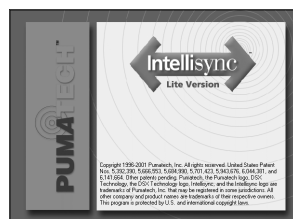

➔ For details, refer to “CLIÉ Application manual” and “Intellisync Lite Help” on your computer.

# Troubleshooting

This section describes how to solve common problems you may encounter when using your CLIÉ handheld.

## Preventing problems

### ..... Making a backup is recommended

We recommend that you make a backup of your data in case of any unexpected trouble. Backing up your data will ensure that it will be saved in the CLIÉ handheld even when you have to perform a hard reset.

#### **Making a backup using the Memory Stick Backup application**

You can make a backup in the “Memory Stick” media using the supplied Memory Stick Backup application. This is the most convenient way to make a backup.

➔ **“Memory Stick” media (optional) is required.**

For details, refer to “Backing up data of your Sony CLIÉ Handheld: Backing up all data to a “Memory Stick” media (using the Memory Stick Backup application)” in “Handbook.”

#### **Making a backup using the HotSync® operation**

The data of your CLIÉ handheld is backed up in your computer every time you perform a HotSync® operation. You can lose the data in your CLIÉ handheld when you perform a hard reset. But, if you make a backup with the HotSync® operation, you can restore any data previously synchronized with your computer during the next HotSync® operation.

However you cannot make a backup for the following applications or data using the HotSync® operation.

- Applications or data installed from a “Memory Stick” media or beamed.
- Some applications and driver files added later, or some data in applications.

For details on applications that cannot be backed up, refer to manuals for each application.

When you want to make a complete backup, use the Memory Stick Backup application. For details on HotSync, refer to “Exchanging and updating data using a HotSync® operation” in “Handbook.”

# Solving problems

Should you encounter problems, please follow the procedure below. Sony recommends that you take a note for displayed messages or alerts to find the key to solve the problem.

## Step 1 Refer to “Troubleshooting Q&A” or manuals for each application.

- Refer to “Troubleshooting Q&A.”
- Click the icon of CLIÉ Info and select Manual on your computer and read the details about the applications.

## Step 2 Refer to the Sony CLIÉ Handheld Support website.

In the Sony CLIÉ Handheld Support website (<http://www.ita.sel.sony.com/support/clié/>), you can see information for the answers to frequently asked questions (FAQ), download provisions of latest programs, information on how to connect peripheral devices etc.

Click the icon of CLIÉ Info and select CLIÉ Customer Support on your computer.

### Note

Thousands of third-party add-on applications are available for the Palm OS® platform. Sony does not support third-party applications. If you have a problem with a third-party application, contact the developer or publisher of that software.



# Getting Help

## Documents To Go

Support information:

<http://www.dataviz.com/Sony/>

(+1) 203-268-0030 (English only)

Mon-Fri excluding national holidays

09:00 a.m-06:00 p.m (USA Eastern)

## Intellisync Lite:

Support information:

<http://www.pumatech.com/sonyclie/>

## For CLIÉ handheld and applications other than the above mentioned:

Sony offers several support options for your CLIÉ handheld. When you have questions or trouble, please refer to one of the following for a solution:

- **Read This First (this guide), Handbook (supplied), and Troubleshooting Q&A (supplied)** describes how to use your CLIÉ handheld.
- **Your Sony CLIÉ Handheld support Website**  
<http://www.sony.com/peg/support/>  
Provides the latest information on your CLIÉ handheld. On this Website, you will find:
  - Frequently Asked Questions (FAQs)
  - Online Operating Instructions
  - Installation information
  - Software updates
  - Online knowledge base
- **The Sony e-mail support service** answers your questions by e-mail.  
Send your question, and a customer service representative will send you a reply. You can use the e-mail form at  
<http://www.sony.com/peg/support/>

- **The Sony fax-back service** provides you with answers to commonly asked questions. You can use this automated service to access a list of available topics and then select the topics that you want to receive. To contact the Sony fax-back service, call 1-877-760-SONY (7669).
- **The Sony Customer Information Service Center** offers information about your CLIE handheld and other Sony products that work with your computer. To contact the Sony Customer Information Service Center, call 1-877-760-SONY (7669).

# ***Additional information***

## **Notes on use**

### **About handling**

- Be sure not to scratch or damage your CLIÉ handheld's screen or the Graffiti<sup>®</sup> writing area. Always use the supplied stylus or a plastic-tipped pointer to tap on the screen.  
Do not use a real pen, pencil, or other sharp object on the screen.
- Do not expose your CLIÉ handheld to rain or moisture. Should water enter the circuitry through the buttons and switches, your CLIÉ handheld may be damaged.
- Your CLIÉ handheld screen is made of glass. Do not drop or submit your CLIÉ handheld to external shock. Do not carry your CLIÉ handheld in your back pocket. If you sit down with your CLIÉ handheld in the back pocket, the CLIÉ handheld may break.
- Avoid using or storing your CLIÉ handheld in locations subject to:
  - extremely high temperature, such as inside a car left exposed to the sun, or near a heater.
  - direct sunlight
  - high humidity
  - excessive dust
- The rubber feet of the cradle may lose their adhesion if they become dirty. If this occurs, wipe the rubber feet with a soft damp cloth to restore their adhesion.

### **About cleaning**

- Clean your CLIÉ handheld with a soft, dry cloth.
- Remove the dirt and dust from the camera lens by wiping with a soft damp cotton swab.

.....

## Battery considerations

### Charging

- It takes approximately four hours to charge your CLIÉ handheld when the battery is empty.
- If you charge your CLIÉ handheld every day, it takes only a few minutes to charge the battery.
- You can operate your CLIÉ handheld while it is being charged.

### Battery life

- With a fully-charged battery, you can use your CLIÉ handheld for approximately 10 days with 30-minute operation each day if you do not use the audio playback function.
- If you set the HOLD switch away from the protect position and turn on the backlight to the maximum level, you can play music continuously for about 2.5 hours.
- If you set the HOLD switch to the protect position, you can play music continuously for about 4 hours.
- Battery life varies depending on the conditions and environment where you use your CLIÉ handheld, or applications to be used.
  - ➔ For details on using the manual, refer to “Specifications” on page 94 in this manual.

### Conserving the battery

- Turn off the backlight under good lighting conditions. For details, refer to “POWER Button” on page 31.
- Change the automatic power-off time setting so that your CLIÉ handheld will automatically turn off after a short period of inactivity.
  - ➔ For details, refer to “Customizing your Sony CLIÉ Handheld (Preferences): Setting the automatic power-off time” in “Handbook.”
- If you play audio files with “Audio Player”, the battery runs out faster.

### Using peripheral devices

If the caution message that warns of low battery-remaining is displayed while you use peripheral devices with your CLIÉ handheld, quit operating them immediately and charge your CLIÉ handheld. If you continue operating, data in your CLIÉ handheld’s memory may be lost.

## **When battery charge gets low**

- When battery charge gets low, a caution message appears on the screen, and operations for “Memory Stick” media or backlight adjustment become unavailable.

If this occurs, perform a HotSync<sup>®</sup> operation to make a backup all the data of your CLIÉ handheld to your computer. Then charge your CLIÉ handheld using the cradle to prevent accidental data loss.

- If your CLIÉ handheld does not turn on when you press the POWER button, charge your CLIÉ handheld immediately.
- The remaining battery indicator does not always reflect the actual battery power remaining. To prevent the battery running out accidentally, charge it frequently even when it is not fully discharged.
- You do not have to replace batteries. When the remaining battery indicator reads zero, place your CLIÉ handheld on the cradle and start charging immediately. Never disassemble your CLIÉ handheld to take out the battery.

## **Do not let the remaining battery indicator read 0**

If your battery drains and you leave your CLIÉ handheld in an uncharged state for an extended period of time, all of the stored data will be erased. Sony recommends that you charge your CLIÉ handheld frequently.

## **Others**

Your CLIÉ handheld may get warm if turned on for a long period. This is not malfunction.

# Specifications

## OS

Palm OS® 5 (ver.5.0)

## CPU

PXA250 200 MHz

## Memory

16 MB (RAM)

User memory range:  
approx. 11 MB

## External input/output

Interface connector  
IrDA (1.2)  
IR port for AV control  
“Memory Stick” slot  
Wireless communication slot  
(CompactFlash® type II)

## Display

TFT color display with backlight,  
320 × 480 dots, 65,536 colors

## Other functions

FM synthesizer  
16 chords  
IMA ADPCM sound (monaural)  
Monaural Speaker  
Monaural Microphone

## Dimensions (exclude projections)

Approx.  $2\frac{7}{8} \times 5\frac{1}{2} \times \frac{15}{16}$  inches  
(72.3 × 136.6 × 23.5 mm) (w/h/d)

## Mass

Approx. 8 oz (220 g) (including the supplied stylus)

## Operating temperature

41 °F to 95 °F (5 °C to 35 °C)

## Audio frequency response

20 Hz to 20,000 Hz

## Audio recording format

ATRAC3  
MP3 (~320 kbps)

## Sampling frequency

44.1 kHz

## Output

Headphone: Stereo mini-jack

## Image

### (for PEG-NX70V only)

Approx. 310,000 pixels  $\frac{1}{5.5}$  inch  
CMOS image sensor

## Lens

### (for PEG-NX70V only)

F2.8/focal length 2.62 mm  
(35 mm film equivalent f=approx.  
50 mm)

## Focus range

### (for PEG-NX70V only)

0.3 m to ∞

## Camera Rotating Angle

### (for PEG-NX70V only)

Approx. 260°

## Camera Finder

### (for PEG-NX70V only)

On the CLIE handheld display  
Image file: 320 × 240, 160 × 240  
Movie file: 320 × 224

**Others (for PEG-NX70V only)**

White Balance (Auto, Indoor A (incandescent light), Indoor B (fluorescent light), Outdoor)  
 Picture effect (Off, B&W (monotone), Sepia (sepia tone), Neg. Art (negative art), Solarization)  
 Brightness Control (-2 to +2)  
 Self-timer function (for image file only)

**Picture size (when recording) (for PEG-NX70V only)**

Image file: 640 × 480, 320 × 240,  
 160 × 120,  
 320 × 480 (vertical frame)  
 Movie file: 160 × 112

**Formats (when recording) (for PEG-NX70V only)**

Image file: JPEG (DCF format)  
 Movie file: Movie Player format

**Picture size (when viewing)**

On the CLIÉ handheld display  
 Image file: 320 × 480, 320 × 240,  
 160 × 120  
 Movie file: 426 × 320, 320 × 240  
 160 × 112

**Formats (when viewing)**

Image file: JPEG (DCF format)  
 Movie file: Movie Player format,  
 MPEG Movie format

**Voice encoding/decoding format**

IMA ADPCM (1ch, 4bit)  
 SP mode (22.05 kHz),  
 LP mode (8 kHz)

**Power requirements**

AC power adapter (supplied):  
 DC 5.2 V (dedicated connector)  
 (The supplied AC cord is for AC 120 V)  
 Battery:  
 Lithium-ion battery (internal)

**Battery life**

Operating PIMs:  
 10 days  
 (when PIMs, such as Date Book, are operated for 30 minutes per day with the backlight off)  
 6 days  
 (when PIMs, such as Date Book, are operated for 30 minutes per day with the backlight on)  
 Playing audio files (in continuous):  
 Approx. 4 hours  
 (when playing audio files with the HOLD switch on)  
 Approx. 2.5 hours  
 (when playing audio files with the HOLD switch off and maximum backlight)  
 Recording movie files (in continuous):  
 Approx. 3.5 hours  
 (when recording movie files with the HOLD switch on)  
 Approx. 1.5 hours  
 (when recording movie files with the HOLD switch off and maximum backlight)  
 Viewing movie files (in continuous):  
 Approx. 3 hours  
 (when viewing movie files with the backlight off)  
 Approx. 2 hours  
 (when viewing movie files with the backlight on)

Recording voice memos  
(in continuous):

Approx. 6 hours  
(when recording movie files with  
the HOLD switch on)

Approx. 2.5 hours  
(when recording movie files with  
the HOLD switch off and  
maximum backlight)

Performing data communication (in  
continuous):

Approx. 2.5 hours  
(when performing data  
communication with PEGA-WL100)

\* The battery life span varies depending  
on the temperature and conditions of  
use.

## Maximum recording time

ATRAC3 format  
(when using a 128MB “Memory  
Stick” media, sold  
separately)

Approx. 120 minutes  
(bit rate: 132 kbps)  
Approx. 160 minutes  
(bit rate: 105 kbps)  
Approx. 240 minutes  
(bit rate: 66 kbps)

MP3 format  
(when using a 128MB “Memory  
Stick” media, sold separately)

Approx. 170 minutes  
(bit rate: 96 kbps)  
Approx. 130 minutes  
(bit rate: 128 kbps)  
Approx. 65 minutes  
(bit rate: 256 kbps)

## Maximum audio recording time

(when using a 128MB “Memory  
Stick” media, sold separately)  
SP mode: Approx. 190 minutes  
LP mode: Approx. 520 minutes

## Maximum movie recording time (for PEG-NX70V only)

(when using a 128MB “Memory  
Stick” media, sold separately)  
Note that the maximum movie  
recording time in continuous  
operation is approx. 60 minutes.  
V:192/A: 32kbps :  
Approx. 70 minutes  
V:96/A: 32kbps :  
Approx. 120 minutes

## Maximum image file recording capacity (for PEG-NX70V only)

(when using a 128MB “Memory  
Stick” media, sold separately)  
640 × 480: Approx. 1,000 files  
320 × 240: Approx. 2,000 files  
160 × 120: Approx. 6,000 files  
320 × 480: Approx. 1,500 files

## ..... System required on a computer

The following system is required on a  
computer to use the Palm Desktop for  
CLIE software and software stored in  
the supplied CD-ROM.

- OS: Microsoft Windows 98 Second Edition, Windows Millennium Edition, Windows 2000 Professional, Windows XP Home Edition, Windows XP Professional



- CPU: Pentium II 400MHz or more (Pentium III 500MHz or more is recommended)
- RAM: 96MB or more (128MB or more is recommended, 256MB or more is recommended for Windows XP)
- Hard drive space: 200MB (350MB or more is recommended)\*
  - \* Requires 185MB or more to install CD database using the SonicStage 1.5 software and space equivalent to the file size to save an audio file. Requires 100MB or more to print out using the PictureGear Studio software.
- Display: High Color or more, 800 × 600 dots or more is recommended
- CD-ROM drive
- USB port
- Pointing device such as a mouse or track pad

Design and specifications are subject to change without notice.

# INDEX

---

## A

---

- AC adapter . . . . . 16
- Add-On applications . . . . . 70
- Address . . . . . 64, 77
- Application manager icon . . . . . 41
- Applications
  - Installing . . . . . 70
  - Pressing . . . . . 45
  - Quitting . . . . . 45
  - Using CLIÉ Application Manual . . . . . 68
- Audio Player . . . . . 76
- Audio Remote Control . . . . . 15

---

## B

---

- BACK Button . . . . . 34
- Basic Operations . . . . . 29
  - Using the Jog Dial™ navigator . . . . . 30
  - Using the Stylus . . . . . 29
- Battery considerations . . . . . 92
- Brightness adjustment icon . . . . . 41

---

## C

---

- Calculator . . . . . 80
- Camera . . . . . 33
- CAPTURE/REC Button . . . . . 32
- Charging . . . . . 16
- CLIE Album . . . . . 72
- CLIE Camera . . . . . 71
- CLIE Files . . . . . 82
- CLIE Launcher . . . . . 44
- CLIE Mail . . . . . 80
- CLIE Memo . . . . . 79
- CLIE Remote Commander . . . . . 81

- CLIE Viewer . . . . . 46, 72
  - Opening/Playing Back Files . . . . . 46
  - Selecting/Deleting Files . . . . . 47
- Components . . . . . 11
- Connecting the cradle to your computer . . . . . 21
- Connecting to the Internet . . . . . 67
- Cradle . . . . . 15, 16, 27

---

## D

---

- Date Book . . . . . 62, 78
- Display panel . . . . . 13
- Documents To Go . . . . . 66, 85
- Dragging . . . . . 30

---

## E

---

- Enjoying image files . . . . . 55
- Enjoying movies . . . . . 57
- Enjoying your CLIÉ Handheld . . . . . 55
- Entering data . . . . . 48
- Exchanging the Date Book and Address data . . . . . 65

---

## F

---

- Front panel . . . . . 40
- Functions of parts . . . . . 31

---

## G

---

- Graffiti® . . . . . 42

---

**H**

---

Hardware keyboard	37
HOLD Switch	33
HotSync®	27, 49

---

**I**

---

Icons for switching the Graffiti/Software Keyboard	42
Image Converter	71
Image Files	55
Enjoying	56
Taking images	55
Initial settings	22
Installing the Palm™ Desktop for CLIE software	19
Intellisync Lite	85
IR port	36

---

**J**

---

Jog Dial™ navigator	30
---------------------	----

---

**L**

---

Listening to music	61
--------------------	----

---

**M**

---

Macromedia Flash Player 5	75
Managing addresses and telephone numbers	64
Managing Schedules	62
Memo Pad	79
“Memory Stick”	59
Memory Stick Backup	83
Memory Stick Export	83
Memory Stick Import	83
“Memory Stick” LED	35

“Memory Stick” Slot	35
Inserting a “Memory Stick” media	35
Removing a “Memory Stick” media	35
Movie files	59
Movie Player	75
Movie Recorder	74
Movies	57
Enjoying	58
Taking movies	57

---

**N**

---

NetFront	81
----------	----

---

**O**

---

Operating style	13
Carrying style	13
Opened style	13
Turned style	14

---

**P**

---

Palm™ Desktop For CLIE software	19
Photo Editor	73
PhotoStand	73
PictureGear Studio	74
Plug adapter	17
POWER Button	31
POWER LED	32

---

**R**

---

REC LED	33
Resetting	52
Hard reset	53
Soft reset	52

## Index

---

### S

---

Scroll Button . . . . .	34
Set date . . . . .	25
Set time . . . . .	24
Setting the user name. . . . .	27
Setting up . . . . .	16
Setting up a network card . . . . .	67
Software keyboard . . . . .	42
SonicStage 1.5 . . . . .	76
Sound Converter 2 . . . . .	84
Sound Utility . . . . .	84
Specifications . . . . .	94
Status bar . . . . .	42
Stylus . . . . .	23, 29
Stylus holder . . . . .	15

---

### T

---

Tapping. . . . .	23, 29
Time zone . . . . .	25
To Do List . . . . .	78
Turning on . . . . .	22, 31

---

### U

---

USB connector . . . . .	21
Using applications . . . . .	68
Using Voice Recorder . . . . .	60

---

### V

---

Viewing image files . . . . .	59
Viewing Microsoft® Word and Microsoft® Excel documents . . . . .	66
VOICE REC Button . . . . .	32
Voice Recorder . . . . .	77

---

### W

---

WARNING. . . . .	4
Wireless Communication Slot . . . . .	38
Inserting the Network Card. . . . .	39
Removing the Network Card. . . . .	39
World Alarm Clock . . . . .	82



Contents of this manual are printed on chlorine-free paper using VOC (Volatile Organic Compound)-free vegetable-oil-based ink.







For the latest information on support  
and accessories,  
check our official Sony CLIE Web site  
**<http://www.sony.com/clie/>**