

Handbook

Personal Entertainment Organizer
PEG-TJ37
PEG-TJ27

CLiÉ™

CLiÉ™ handheld basic operations

Entering text on your CLiÉ™ handheld

Exchanging and updating files/data using the HotSync® operation

Customizing your CLiÉ™ handheld (Preferences)

Exchanging and updating files/data using the HotSync® operation (Other HotSync® operations)

Using “Memory Stick™” media

Beaming

Backing up your CLiÉ™ handheld data and applications

Protecting your data with a password

Enhancing features with add-on applications

Transferring data from another CLiÉ™ handheld



Introduction

This manual explains the basic operations and useful features of your CLIÉ™ handheld.

Using your CLIÉ™ handheld for the first time

The basic features and operations are explained in detail (pages 9-75).

CLIÉ™ handheld basic operations

Explains the basic operations of your CLIÉ handheld and how to use the applications.

Entering text on your CLIÉ™ handheld

Explains how to enter text on your CLIÉ handheld.

Exchanging and updating files/data using the HotSync® operation

Explains how to use the HotSync feature with your computer.

CLIÉ™ handheld advanced operations

Useful and advanced features to make full use of your CLIÉ™ handheld are explained in detail (pages 76-190).

Customizing your CLIÉ™ handheld (Preferences)

Explains how to customize your CLIÉ handheld.

Exchanging and updating files/data using the HotSync® operation (Other HotSync® operations)

Explains the various methods of HotSync® operations.

Using “Memory Stick™” media

Explains how to use files/data stored on “Memory Stick” media.

Beaming

Explains how to exchange data or applications with another CLIÉ handheld by beaming.

Backing up your CLIÉ™ handheld data and applications

Explains how to back up the data and applications of your CLIÉ handheld.

Protecting your data with a password

Explains how to assign a password to restrict the use of your CLIÉ handheld or to protect your data.

Enhancing features with add-on applications

Explains how to install additional applications on your CLIÉ handheld.

Transferring data from another CLIÉ™ handheld

Explains how to transfer data from your old CLIÉ handheld to your new CLIÉ handheld.

The following manuals are included with your CLIÉ handheld.
Refer to the following together with this manual.

Printed manual

* If your CLIÉ handheld was purchased in Europe, the manual is not in printed format, but is included as a PDF file on the **Installation CD-ROM**.

Read This First (Operating Instructions)*

Explains how to set up your CLIÉ handheld and computer, and basic operations.

For safe use, make sure you read the supplied “Safety & Regulations Guide”.

Internet Connection Guide (for PEG-TJ37 only)

Explains how to connect to the Internet by using the wireless LAN function.

Manuals to be read on your computer

The following manuals are automatically installed on your computer after you set up your CLIÉ handheld and computer.

► For details on each manual, refer to “Using CLIÉ Manuals with your computer” in the “Read This First (Operating Instructions)”.

Handbook (This manual, PDF format*)

Explains the basic operations and advanced features of your CLIÉ handheld.

CLIÉ Application Manual (HTML format**)

Explains how to use the supplied applications in detail.

Troubleshooting Q&A (PDF format*)

Helps in solving common problems that you may have while using your CLIÉ handheld.

* You can read the manual on your computer window using **Adobe Reader**. If **Adobe Reader** is not installed on your computer, install it from the supplied Installation CD-ROM.

** You can read the manual on your computer using **Internet Explorer Version 5.0** or later.

Notes

- Some of the illustrations in this manual (Handbook) may not be consistent with your CLIÉ handheld.
 - For details on your CLIÉ handheld, refer to the “Read This First (Operating Instructions)”.
- Some of the accessories described in this manual (Handbook) may not be supported by your CLIÉ handheld.
- This manual supports PEG-TJ37 and PEG-TJ27.
 - The illustrations used in this manual are for PEG-TJ37, unless specified otherwise.
 - Differences between PEG-TJ37 and PEG-TJ27 are specified in each relevant section.

Table of Contents

CLIE™ handheld basic operations

Basic operations	10
Using the stylus	10
Using the Jog Dial™ navigator	12
Starting an application	14
Starting an application on the CLIE Launcher	15
Quitting an application	16
Using CLIE Launcher	17
Locating the components	17
CLIE Launcher group	18
Using Favorite Applications (shortcuts)	22
Application Manager icons	24
Displaying information about applications	25
Menu List	27
Using the Palm OS® Standard screen	29
Switching to the Palm OS® Standard screen	29
Starting an application	31
Changing the display style of the Palm OS® Standard screen	36
Displaying applications by category	38
Finding records	40
Using the Find option	40
Changing fonts	42
Common menu items	43

Continued on next page
.....

Entering text on your CLIÉ™ handheld

Entering text on your CLIÉ™ handheld	45
Using Graffiti® 2 writing to enter text	46
What is Graffiti® 2?	46
Writing a stroke on your CLIÉ™ handheld	47
Using the Graffiti® 2 writing area	48
Graffiti® 2 character list.	50
Entering text	56
Using navigation strokes and shortcuts	58
Using Decuma Input to enter text (for PEG-TJ37 only).	60
Entering text	60
Using the on-screen keyboard to enter text	65
Entering text	65

Exchanging and updating files/data using the HotSync® operation

What is the HotSync® operation?	69
Performing the HotSync® operation	71
Performing the HotSync® operation with the USB cable (Local HotSync®)	71
Using Palm™ Desktop for CLIÉ.	73
Starting Palm™ Desktop for CLIÉ.	73
Locating components of Palm™ Desktop for CLIÉ	74
Basic operations of Palm™ Desktop for CLIÉ	75

Continued on next page
.....

Customizing your CLIÉ™ handheld (Preferences)

What you can do with Preferences	77
Setting the Graffiti® 2	79
Creating Graffiti® 2 ShortCuts	80
Viewing the battery information and media information, and changing the volume level	81
Adjusting the Digitizer	82
Setting the Network preferences for a wireless LAN (for PEG-TJ37 only)	83
Setting a wireless LAN access point manually	83
Searching and setting a wireless LAN access point manually	85
Connecting your CLIÉ handheld to a wireless LAN access point automatically	86
Checking the wireless LAN communication status	87
Setting the Network preferences for your provider and dial-up server	88
Selecting a service template	88
Entering a user name	88
Entering a password	89
Selecting a connection	89
Setting the telephone information	90
Adding detailed information to a service template	92
Duplicating/deleting additional service templates	94
Creating log-in scripts	95
Using the Network preferences menus	98
Assigning applications to application buttons	99
Customizing the full-screen pen stroke activities	100
Setting the automatic power-off time	101
Setting sounds	102
Turning the Alarm LED on or off	103
Turning the Beam Receive feature on or off	104
Selecting the screen color theme	105
Setting the display format for time, date, and numbers	106
Selecting a regional default	106
Customizing your own settings	106
Adding/Changing communication device preferences	107
Setting up the Date & Time preferences	108
Setting the date	108
Setting the time	108
Setting the time zone and daylight saving time	109

Continued on next page
.....

Exchanging and updating files/data using the HotSync® operation (Other HotSync® operations)

Customizing HotSync® application settings (Conduit)	111
Synchronizing with external data (File Link)	113
Customizing HotSync® Manager startup and HotSync® setup options	114
Performing the HotSync® operation via a wireless LAN (for PEG-TJ37 only)	115
Performing the IR HotSync® operation	118
Performing the HotSync® operation via a modem	121
Performing the HotSync® operation via a network	127
Performing the HotSync® operation via LAN (LANSync)	131

Using “Memory Stick™” media

Using “Memory Stick™” media	135
The type of storage media you can use with your CLIÉ handheld	135
Using “Memory Stick” media	135
Protecting the files/data on “Memory Stick” media	138
Starting an application on “Memory Stick” media	139
Viewing information of “Memory Stick” media (Card Info)	141

Assigning a name to “Memory Stick” media	142
Formatting “Memory Stick” media	143
Exchanging data via “Memory Stick” media	145
Starting CLIE Files	145
Copying your CLIÉ handheld data to “Memory Stick” media	148
Copying data on “Memory Stick” media to your CLIÉ handheld	151
Deleting files/directories on “Memory Stick” media	153
Extracting a Zip file	155
CLIE Files menu items	158
Exchanging files/data without using CLIE Files	159
Notes on starting applications from “Memory Stick” media	160

Beaming

Beaming between your CLIÉ handheld and another Palm OS® PDA	162
What you can do with beaming	162
Beaming information	163

Backing up your CLIÉ™ handheld data and applications

Backing up your CLIÉ™ handheld data and applications	167
Backing up data and applications to your computer with the HotSync® operation	167
Backing up data and applications to “Memory Stick” media using Memory Stick Backup	168

Continued on next page
.....

Protecting your data with a password

- Entering personal information . . . 172
- Locking your CLIÉ handheld with a password (Data protection). 174
 - Turning off your CLIÉ handheld after locking 174
 - Setting your CLIÉ handheld to be locked automatically. 176
- Protecting data. 177
 - Assigning a password 177
 - Changing or deleting a password. 178
 - Hiding or masking private data 179

INDEX 191

Enhancing features with add-on applications

- Enhancing features with add-on applications 181
- Installing 182
 - Installing from your computer 182
 - Installing applications on "Memory Stick" media 184
 - Installing from the Internet . . . 184
 - Deleting installed add-on applications 185

Transferring data from another CLIÉ™ handheld

- Transferring data from another CLIÉ™ handheld. 188
 - Transferring data using Palm™ Desktop for CLIÉ. 188

CLIE™ handheld basic operations

This chapter explains the basic operations of your CLIE handheld such as using the stylus and the Jog Dial™ navigator, locating components and starting applications.

This chapter also gives an overview of menus that are common to applications and explains how to find a record and select character fonts.

Basic operations	10
Starting an application	14
Using CLIE Launcher	17
Using the Palm OS® Standard screen	29
Finding records	40
Changing fonts	42
Common menu items	43

Basic operations

Using the stylus and the Jog Dial™ navigator.

Using the stylus

What is a stylus?

A stylus is a pen-like device for operating your CLIÉ handheld by directly touching the screen.

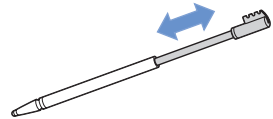

Tip

Where is the stylus located?

The stylus is stored in your CLIÉ handheld.

The exact storage location varies depending on your model.

- ➔ For details, refer to “CLIÉ™ handheld components” in the “Read This First (Operating Instructions)”.

Note

To prevent losing the stylus, always put it back in its holder on your CLIÉ handheld after use.

Continued on next page

You can operate your CLIÉ handheld using the stylus in the following ways.

Tapping

Lightly pressing the required item on the screen with the stylus is called “Tapping”. When entering text with the on-screen keyboard or starting an application, “tap” the desired button or icon with the stylus.

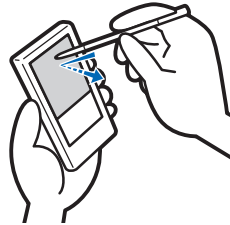

Dragging

Touching the required item on the screen with the stylus and moving it along the screen surface is called “Dragging”. Just as you “drag” the mouse of your computer, you can use the stylus to “drag” the scroll bar to scroll the screen, or to “drag” across characters to highlight them.

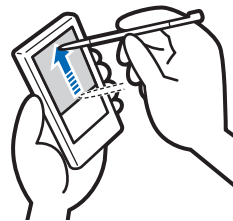

Using the Jog Dial™ navigator

What is the Jog Dial™ navigator?

Your CLIÉ handheld is equipped with a Jog Dial™ navigator, located on the front side of your CLIÉ handheld.

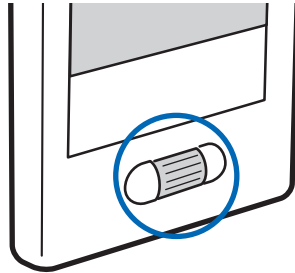

Rotating the Jog Dial™ navigator

Rotate the Jog Dial™ navigator to select the application you want to start.

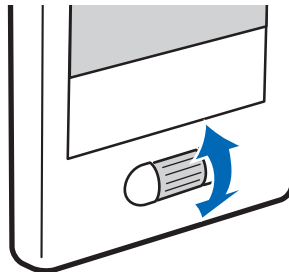

Continued on next page

Pressing the Jog Dial™ navigator

Press the Jog Dial™ navigator to select an item or to start a selected application.

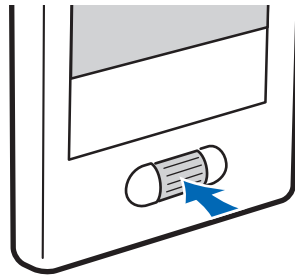

Note

The operations you can perform using the Jog Dial™ navigator vary depending on the application.

- ➔ For details on the operations of each application, refer to the “CLIÉ™ Application Manual” (HTML format).

Tip

Rotating while pressing the Jog Dial™ navigator

In some applications, operations are executed by pressing and rotating the Jog Dial™ navigator.

Starting an application

Software that you can use on your CLIÉ handheld to execute a task, such as **Date Book**, **To Do List**, is called an “application”. You need to start an application to operate your CLIÉ handheld.

Note

For details on starting applications from “Memory Stick” media, refer to page 139.

There may be some system limitations when starting applications that are stored on “Memory Stick” media in the Home screen.

Tip

What is the Home screen?

The screen displayed when you turn on your CLIÉ handheld or tap  (Home), is called the Home screen. On your CLIÉ handheld, the CLIE Launcher and the Palm OS Standard screen are installed as the Home screen. The screen specific to your CLIÉ handheld, the CLIE Launcher, is displayed by default. The CLIE Launcher is used in this manual as the Home screen.

Starting an application on the CLIE Launcher

- 1 Tap  (Home).

The CLIE Launcher is displayed.

- 2 Select an application icon by rotating the Jog Dial™ navigator and press the Jog Dial™ navigator to start the application.



Tip

You can also tap an application icon on the CLIE Launcher to start the application.

Quitting an application

You do not need to save data manually on your CLIÉ handheld as you do with the computer.

All the changes in the application that you are working on are automatically saved, and the last screen you worked on is displayed when you restart the application.

Display the CLIE Launcher to switch to another application while you are working on an application.

You can select one of two methods to display the CLIE Launcher as follows.

Return to the CLIE Launcher by tapping  (Home), then start another application.

Switch to another application assigned to application buttons by pressing an application button on your CLIÉ handheld.

Note

For some applications, you need to save data manually.

- ➔ For details, refer to the “CLIÉ Application Manual” (HTML format).

Using CLIE Launcher

Locating the components

Tip

Tap  (Home) to display the CLIE Launcher if it is not displayed.



1 CLIE Launcher groups list (page 18)

The list of CLIE Launcher groups is displayed.

2 Favorite Applications (shortcuts) (page 22)

You can create shortcuts to favorite applications.

3 Application Manager icons (page 24)

4 Application icon list

The application names and their icons are displayed.



CLIE Launcher group

You can organize applications by group.

Note

Applications stored on “Memory Stick” media cannot be grouped.

Editing groups

- 1 Tap  (Home).
The CLIE Launcher is displayed.
- 2 Tap  (Menu).
The menu is displayed.
- 3 Tap [Edit CLIE Launcher Group] from [CLIE Launcher].
The **CLIE Launcher Group** screen is displayed.



Note

CLIE Launcher groups differ from Palm OS® Standard screen categories.

Continued on next page

4 Select a group to edit, and tap [Edit].

The display of the **CLIE Launcher Group** screen is changed.



Name: You can rename groups.

Ordering listed applications: Select an application and tap [Up] or [Down] to reposition applications on the CLIE Launcher.

Adding applications: Tap [Add] to display the list, and select an application to add.

Removing applications: Select an application to be removed and tap [Remove]. Removed applications will be listed in the Unfiled group.

Note

The Unfiled group cannot be renamed.

5 Tap [Done].

The **CLIE Launcher Group** screen display returns.

6 Tap [Done].

The CLIE Launcher is displayed.

Continued on next page

Tip

When the check box next to [Use Drag&Drop] (page 28) on the **CLIE Launcher Preferences** screen is , you can add an application to a group by dragging its icon and dropping it in the group on the CLIE Launcher.

Ordering listed groups

- 1 Select a group on the **CLIE Launcher Group** screen.
- 2 Tap [Up] or [Down].
The order of listed groups on the CLIE Launcher is changed.

Creating a new group

- 1 Tap [New] on the **CLIE Launcher Group** screen.
The **New CLIE Launcher Group** dialog box is displayed.
- 2 Enter a new group name, and then tap [OK].



Note

Groups that do not include an application are not listed on the CLIE Launcher.

Continued on next page



Deleting a group

- 1 Select a group you want to delete and tap [Delete] on the **CLIE Launcher Group** screen. If the group to be deleted includes any applications, the **Delete CLIE Launcher Group** dialog box will be displayed. In the dialog box, tap [Yes] to delete the group. The applications included in the deleted group will be listed in the Unfiled group.





Note

You cannot delete the Unfiled group.

Selecting a group

- 1 Tap  (Home).
The CLIE Launcher is displayed.
- 2 Press  (the Left button).
You can now scroll the CLIE Launcher groups list with the Jog Dial™ navigator.
- 3 Rotate the Jog Dial™ navigator to select a group.
If you press the Jog Dial™ navigator, the selection area moves to an application icon of the selected group.

Tips

- When you press , the selection area moves to an application icon.
- Applications saved on “Memory Stick” media will be listed in  (Card).
- You can select a group by tapping  (Home) repeatedly, by tapping  at the right of the CLIE Launcher groups list on the CLIE Launcher groups list, or by tapping a group name on the CLIE Launcher groups list directly.



Using Favorite Applications (shortcuts)

You can create Favorite Applications (shortcut) for frequently used applications.

Note

You cannot create a Favorite Application (shortcut) for an application on “Memory Stick” media.

Creating a Favorite Application (shortcut)

- 1 Tap  (Home).
The CLIE Launcher is displayed.
- 2 Tap  (Menu).
The menu is displayed.
- 3 Select [Edit Favorite Applications] from [CLIE Launcher].
The **Favorite Application** screen is displayed.

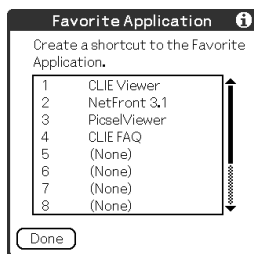

Tip

You can also tap the empty Favorite Application (shortcut) box on the CLIE Launcher to display the **Favorite Application** screen.

Continued on next page

- 4 Tap a Favorite Application (shortcut) number that you want to assign to an application. The list of applications is displayed. Tap the application name to create a Favorite Application (shortcut).

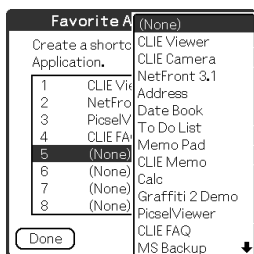

Tip

You can create 12 shortcuts.

- 5 Tap [Done].

Note

When you delete an application that is saved as a shortcut, the shortcut is also automatically deleted from the Favorite Application list.

Tip

When the check box next to [Use Drag&Drop] (page 28) on the **CLIE Launcher Preferences** screen is , you can assign a Favorite Application (shortcut) box to an application by dragging the application icon and dropping it in an empty Favorite Application (shortcut) box.

Continued on next page

To delete a Favorite Application (shortcut)

In step 4, tap the Favorite Application (shortcut) number that you want to delete, and select [(None)] at the top of the list.

Tip

When the check box next to [Use Drag&Drop] (page 28) on the **CLIE Launcher Preferences** screen is , you can cancel the assigned Favorite Application (shortcut) by dragging the application icon and dropping it in  (page 24) at the top right of the CLIE Launcher.

Application Manager icons

You can manage your applications with the application manager icons.

The following icons are featured as standard functions:



: Transferring applications

Displays the **Beam** screen (page 163).



: Displaying application information (page 25)





: Deleting applications (page 185)

Tips

- Additional functions will be added to manager icons when you install certain applications.
- When the check box next to [Use Drag&Drop] (page 28) on the **CLIE Launcher Preferences** screen is , you can manage an application by dragging its icon and dropping it in each application manager icon.

Displaying information about applications

- 1 Tap  (Home).
The CLIE Launcher is displayed.
- 2 Tap .
- 3 Tap an application name whose information you want to display.
The **CLIE Launcher Info** screen is displayed.
Tap [OK] to close the screen.



Tip

When the check box next to [Use Drag&Drop] (page 28) on the **CLIE Launcher Preferences** screen is , you can display information of an application by dragging its icon and dropping it in  at the top right of the CLIE Launcher.

Continued on next page

Editing a description

Tap [Edit] to display the **Edit Description** dialog box and enter the new description.

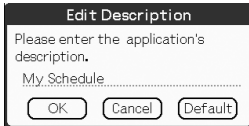

[OK]: Changes to the description entered.

[Cancel]: Cancels the description entered.

[Default]: Restores the default description.

Menu List



The following list describes the functions of each menu on the CLIE Launcher.

CLIE Launcher menu

[Delete...]	Deletes an application (page 185).
[Beam...]	Sends an application or data to another Palm OS PDA device via the IR port (page 162).
[Edit CLIE Launcher Group]	Edits a group of applications (page 18).
[Edit Favorite Applications]	Creates a shortcut to an application (page 22).
[Info...]	Displays the version, memory size, and the number of records of an application.
[Copy...]	Copies an application.

Continued on next page



Options menu

[Preferences...]	Makes settings for the CLIE Launcher screen. [Show Expansion Cards] Check the box to display the applications on “Memory Stick” media. (Default: <input checked="" type="checkbox"/>) [Display Animation] Check the box to adjust on-screen motion such as the scrolling operation. (Default: <input checked="" type="checkbox"/>) [Use Drag&Drop] Check the box to enable the Drag&Drop function. (Default: <input type="checkbox"/>) [Use Beam Icon To Beam Only] (On the model of your CLIE handheld, beaming starts automatically by tapping  (Beam) regardless if the box is <input type="checkbox"/> or <input checked="" type="checkbox"/> .) Check the box to display the Beam screen automatically when you tap  (Beam). (Default: <input type="checkbox"/>) [Display] [Icon]: Displays a simple description for any application. [Icon (Small)]: Displays a simple description for a selected application. (Default: Icon (Small))
[Go To Standard View]	Switches to the Palm OS Standard screen (page 29).
[About Applications]	Displays version information of the application.

Using the Palm OS® Standard screen

Switching to the Palm OS® Standard screen

Your CLIE handheld is initially set to display the CLIE Launcher when you tap  (Home). To switch to the Palm OS Standard screen, follow the procedure below.

- 1 Tap  (Home).
The CLIE Launcher is displayed.
- 2 Tap  (Menu).
The menu is displayed.
- 3 Tap [Options].
The **Options** menu is displayed.
- 4 Tap [Go To Standard View] from [Options].
The Home screen is switched to the Palm OS Standard screen.

Tap to display menus.

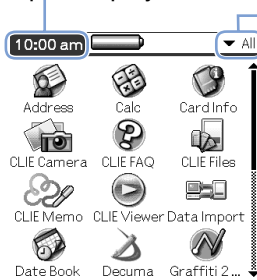

Tap to select a category to be displayed.



Tip

You can display categories in sequence by tapping  (Home).

Note

Palm OS® Standard screen categories differ from CLIE Launcher groups.

Switching to the CLIE Launcher

- 1** Tap  (Home).
The Palm OS® Standard screen is displayed.
- 2** Tap  (Menu).
The menu is displayed.
- 3** Tap [Options].
The **Options** menu is displayed.
- 4** Tap [Go To CLIE Launcher View] from [Options].
The Home screen is switched to the CLIE Launcher.

Starting an application

Note

For details on starting applications on “Memory Stick” media, refer to page 139.

There may be some system limitations when starting applications on “Memory Stick” media in the Palm OS Standard screen.

Starting an application with the Jog Dial™ navigator and (the Left/Right buttons)

Tip

There are three different modes you can set the Jog Dial™ navigator and  (the Left/Right buttons) to select applications on the CLIE Launcher screen.

- ➔ For details, refer to “Changing the preferences of the start-up screen for the Jog Dial™ navigator operation and  (the Left/Right buttons)” on page 32.

1 Tap (Home).

The Palm OS® Standard screen is displayed.

2 Move the selection area with the Jog Dial™ navigator and (the Left/Right buttons) to select the application you want to start.

Continued on next page

3 Press the Jog Dial™ navigator.

The application starts.



Tips

- When you rotate the Jog Dial™ navigator, the selection area moves up and down.
- To move the selection area left or right, press ◀/▶ (the Left/Right buttons). When the selection area reaches the end of a row, it moves to the beginning of the next row.

Changing the preferences of the start-up screen for the Jog Dial™ navigator operation and ◀/▶ (the Left/Right buttons)

When you rotate the Jog Dial™ navigator, the reaction is one of the following three modes.

[PopUp] : The selection area moves up and down in the pop-up list of applications.

[Direct] : The selection area moves from left to right across each line, moving to the next line when it reaches the end of each line. When you press ◀/▶ (the Left/Right buttons), the display shifts to the top half (left button) or bottom half (right button) of the application icons.

[CrossNavigation] : (Default setting) The selection area moves up and down a row when you rotate the Jog Dial™ navigator. When you press ◀/▶ (the Left/Right buttons), the selection area moves over one row left or right.

Continued on next page

Using the Palm OS® Standard screen

To change the Jog Dial™ navigator / ◀ / ▶ (the Left/Right buttons) mode, follow these steps.

- 1 Tap  (Menu) on the Palm OS® Standard screen.

The menu is displayed.

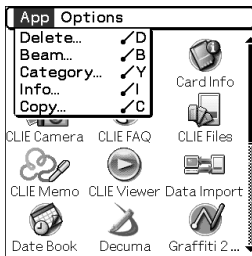

- 2 Tap [Options].

The **Options** menu is displayed.

- 3 Tap [Preferences...] from [Options].

The **Preferences** dialog box is displayed.



Continued on next page

- 4 Tap ▼ next to [Jog Select:], and select the desired reaction-mode.

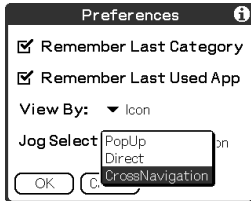

- 5 Tap [OK].

When the Jog Dial™ navigator is rotated or ◀/▶ (the Left/Right buttons) are pressed, the selection area moves according to the selected mode.



PopUp mode

Direct mode

Starting an application by tapping an application icon

- 1 Tap  (Home).

The Palm OS® Standard screen is displayed.

- 2 Tap the icon of the application you want to start.

The application starts.

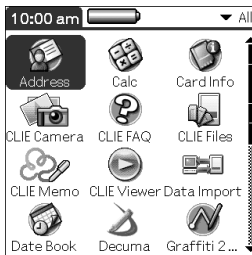

Changing the display style of the Palm OS® Standard screen

On the Palm OS Standard screen, you can display applications in either list or small-icon format. You can also choose to display your favorite category or last-used application when the Palm OS Standard screen is displayed.

The Icon view is displayed by default.

1 Tap  (Home).

The Palm OS® Standard screen is displayed.

2 Tap  (Menu).

The menu is displayed.

3 Tap [Options].

The **Options** menu is displayed.

4 Tap [Preferences...] from [Options].

5 Tap ▼ next to [View By:], and select [List], [Icon], [List (Small)] or [Icon (Small)].

6 Tap [OK].

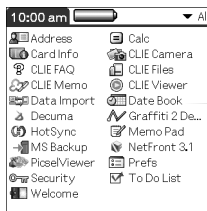

List view

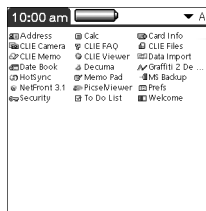

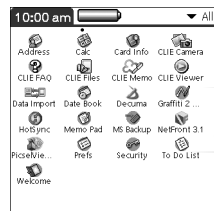

List (Small) view



Icon (Small) view

Setting to display the last-opened category or the last-used application when the Palm OS® Standard screen is displayed

- 1 Tap  (Home).
The Palm OS® Standard screen is displayed.
- 2 Tap  (Menu).
The menu is displayed.
- 3 Tap [Options].
The **Options** menu is displayed.
- 4 Tap [Preferences...] from [Options].
- 5 Tap / (check boxes) next to [Remember Last Category] or [Remember Last Used App], to select the desired settings.
The check boxes are selected/deselected by tapping.

Tip

The check boxes are , in the default setting.

- 6 Tap [OK].

Note

Applications are not recognized as the last-used applications and categories in the following cases:

- Pressing an application button to start an application or category.
- Switching the screen from the Palm OS Standard screen to the CLIE Launcher.

Displaying applications by category

You can choose to display applications by category.

Categorizing applications

-
- 1 Tap  (Home).

The Palm OS® Standard screen is displayed.

-
- 2 Tap  (Menu).

The menu is displayed.

-
- 3 Tap [App].

The **App** menu is displayed.

-
- 4 Tap [Category...] from [App].

The **Category** screen is displayed.

-
- 5 Tap ▼ next to each application, and select the category.

Note

To create a new category, tap ▼ at the top right of the Palm OS Standard screen, and then tap [Edit Categories...] to display the **Edit Categories...** screen.

Tap [New], enter a category name, and tap [OK]. Tap [OK] again when the new category is added.



-
- 6 Tap [Done].

Displaying applications by category

1 Tap (Home).



The Palm OS® Standard screen is displayed.

2 Perform either of the following operations.

- Repeatedly tap  (Home) to display the categories in sequence.
- Tap  (Home) to deselect a application, then repeatedly press the Jog Dial™ navigation to display the categories in sequence.
- Tap ▼ at the top right of the screen, and select the category you want to display.

Tip

If you select [All], all applications are displayed on the Palm OS Standard screen.

If you often use the Jog Dial™ navigator or  /  (the Left/Right buttons), it is convenient to select [All].

Note

CLIE Launcher groups differ from Palm OS® Standard screen categories.

Finding records

Using the Find option

You can find records, such as Date Book, Address Book, To Do List, or Memo Pad data on your CLIÉ handheld, by entering the whole word or the first few letters. The search results are displayed by application. This feature helps if you do not remember which application you used to create the record you are searching for.

Note

The Find option is not compatible with some application data.

1 Tap (Find).

The **Find** dialog box is displayed.



2 Enter the text you want to find.

You can enter letters, symbols, or numbers.

3 Tap [OK].

The **Find** option starts to search and displays the list of search results. Comments attached to data can also be searched for.

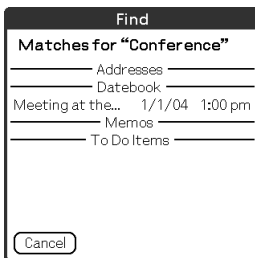

Continued on next page

4 Tap the data you want to view in the list of search results.

The application associated with the data automatically starts and opens the data.

To stop searching

Tap [Stop] and [Exit].

To resume the search, tap [Find More].

Note

The **Find** option is not case sensitive; searching for “sony” also finds “Sony”.

Tip

If you select text in an application prior to tapping  (Find), the text is automatically placed in the **Find** dialog box.

Changing fonts

You can change the font style in applications such as **Date Book** or **Address Book** according to your preference. A font style can be assigned to each application.

1 Start an application whose font style you want to change.

2 Tap  (Menu).
The menu is displayed.

3 Tap [Options].
The **Options** menu is displayed.

4 Tap [Font...] from [Options].
The **Select Font** dialog box is displayed.

5 Tap the font style you want to use.

6 Tap [OK].
The text in the application is displayed in the font style you selected.

Note

The font style cannot be changed for some applications.

Common menu items

The following list describes functions that are common for your CLIÉ handheld applications, such as **Date Book**, **Address Book**, **To Do List**, and **Memo Pad**. To display the menu, tap  (Menu) while the application is opened.

For menu items that are specific to an application, refer to the menu description for each application.

Note

Some menus may not be displayed depending on the display style.

Edit Menu

[Undo]	Reverses the action of the last edit command. For example, if you used [Cut] to remove text, [Undo] restores the text you removed.
[Cut]	Removes the selected text and stores it temporarily in the memory of your CLIÉ handheld. You can paste the text you cut into another area of the current application or into other applications.
[Copy]	Copies the selected text and stores it temporarily in the memory of your CLIÉ handheld. You can paste the text you copied into another area of the current application or into other applications.
[Paste]	Inserts the text that you cut or copied at the selected point. If you did not cut or copy text previously, paste has no effect.
[Select All]	Selects all of the text in the current record or screen. This function enables you to cut or copy all of the text and paste it at the selected point.
[Keyboard]	Opens the on-screen keyboard.
[Graffiti 2 Help]	Opens the list of Graffiti [®] 2 character strokes. You can view the required stroke order for characters as needed.



Entering text on your CLIÉ™ handheld

This chapter explains how to enter text on your CLIÉ handheld.

Entering text on your CLIÉ™ handheld	45
Using Graffiti® 2 writing to enter text	46
Using Decuma Input to enter text (for PEG-TJ37 only)	60
Using the on-screen keyboard to enter text	65

Entering text on your CLIÉ™ handheld

You can enter text by the following methods, other than the hardware keyboard.

Handwriting input system

Graffiti® 2 (page 46)

Enter text using the freehand input characters, called Graffiti 2. Once you get used to entering text using Graffiti 2, it is much faster than entering text with the on-screen keyboard.

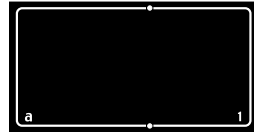

Decuma Input (for PEG-TJ37 only) (page 60)

Decuma Input converts your handwriting into typed text and can be used to input text with any application. Simply write in the input area in the lower part of the screen. The interpretation of your handwriting is displayed in the same place you write.



On-screen keyboard (Input panel) (page 65)

Enter text by tapping the keyboard displayed on the screen.

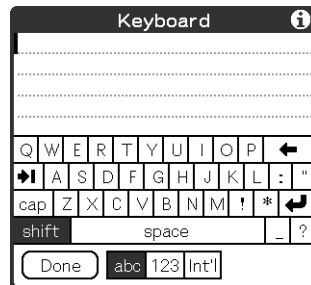

Using Graffiti® 2 writing to enter text

This section describes the procedure for creating letters, numbers, punctuation marks and symbols, and teaches you some Graffiti® 2 tips and tricks.

What is Graffiti® 2?

Graffiti® 2 is a unique writing method for quickly and easily entering text into CLIÉ applications. Text is entered in the Graffiti® 2 area using the stylus. Graffiti® 2 recognizes your handwriting and immediately converts it into typed text.

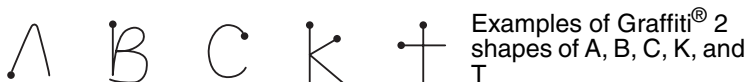

Displaying the on-screen Graffiti 2 Help

Drag the stylus to the top of the screen from the Graffiti® 2 writing area. Graffiti 2 Help opens a series of screens that show the character set of Graffiti® 2 writing.

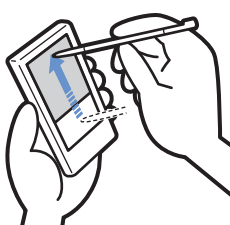

Tip

You can customize the way you write the characters t, p, y, and \$. For details, refer to “Setting the Graffiti® 2” on page 79.

Writing a stroke on your CLIÉ™ handheld

The dot on each stroke shows where to begin the stroke

Certain characters have similar stroke shapes, but different beginning and end points. Always begin each stroke from the dot and lift the stylus at the end.

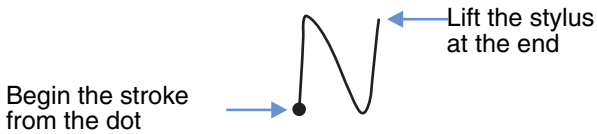

Note

You do not need to create the dot when you actually write a stroke. It is only shown in this manual to illustrate where to begin the stroke.

Using the Graffiti® 2 writing area

The Graffiti® 2 writing area is divided into two halves: one for writing the lower case letters of the alphabet and one for writing numbers. The area around the division line (the line which connects the division marks located at the top and bottom of the Graffiti® 2 writing area) is used for writing upper case letters of the alphabet.

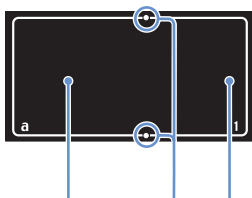

Lower case letter area Division marks Number area

Writing upper case letters

To enter an upper case letter, write the stroke(s) across the division line of the Graffiti® 2 writing area*.

* **Memo Pad** is used as an example application in this manual.

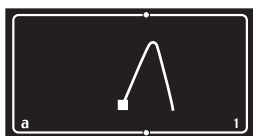

Write the stroke(s)
across the division line

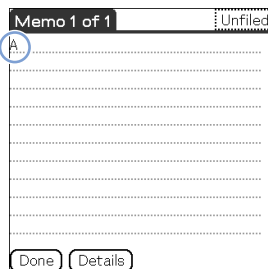

Writing lower case letters

To enter a lower case letter, write the stroke(s) on the Lower case letter area of the Graffiti® 2 writing area.

Continued on next page



Write the stroke(s)
within this area

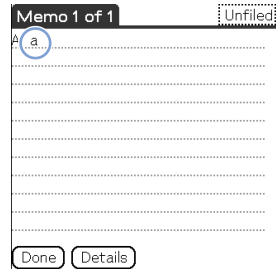

Writing numbers

To enter a number, write the stroke(s) on the Number area of the Graffiti® 2 writing area.



Write the stroke(s)
within this area

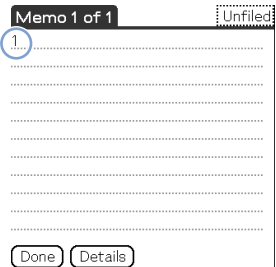

Graffiti® 2 character list

Alphabet

A	Λ A A A a	N	· N n n
B	B B b b	O	o o
C	C	P	p p
D	D D d d	Q	q q q q
E	ε e	R	R R r
F	Γ F f f ² f ¹	S	S
G	G G g g	T	² t
H	h h H	U	U U
I	i ¹ i ²	V	v v
J	J J j ² j ¹	W	w
K	k ²	X	x ¹ x ²
L	L l	Y	y y
M	m m	Z	Z z

Numbers

1	i 1	6	6
2	2 2	7	7
3	3	8	8 8
4	¹ 4 ² 4 4	9	9 9
5	5 ¹ 5 ²	0	o o

Continued on next page

Writing symbols

To enter a symbol, activate Symbol mode. In Symbol mode, you can write on the Lower case letter area or the Number area of the Graffiti® 2 writing area. Follow the steps below to enter a symbol.

1 Write the stroke | anywhere within the Graffiti® 2 writing area.

The Punctuation Shift indicator is displayed on the screen to show that you are in Symbol mode.

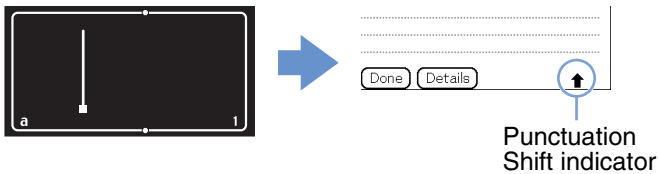

Tip

You can write the stroke |, to enter Symbol mode or exit Symbol mode, on either the Lower case letter area or the Number area.

2 Write the symbol stroke(s).

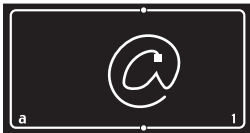

Tips

- Write the stroke(s) as soon as you enter Symbol mode before Symbol mode automatically exits.
- You can write the stroke(s) anywhere in the Graffiti® 2 input area when Symbol mode is activated.

Continued on next page

3 Write the stroke | again.

This will enter the symbol, and exit Symbol mode.

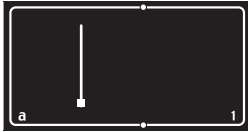

Tip

Some symbols can be entered without activating Symbol mode. You need to write the stroke(s) on the Lower case letter area or the Number area of the Graffiti® 2 writing area, depending on the symbol.

➔ For details, refer to Graffiti 2 Help on your CLIE handheld or the next page. This shows which symbols need to be written on the Lower case letter area of the Graffiti® 2 writing area, and which need to be written on the Number area.

Continued on next page

Symbol (Lower case letter area)

You can write the following stroke(s) directly in the Lower case letter area without switching to Symbol mode.

. (Period)		@	
, (Comma)		"	
' (Apostrophe)		Space	
? (Question mark)		Carriage return	
! (Exclamation mark)		Tab	
&			

Symbol (Number area)

You can write the following stroke(s) directly in the Number area without switching to Symbol mode.

. (Period)		\ (Back slash)	
, (Comma)		/ (Slash)	
~ (Tilde)		((Left parenthesis)	
-) (Right parenthesis)	
+		=	
*			

Continued on next page

Symbol (Symbol mode)

You can input the following symbols in Symbol mode.

. (Period)	•	((Left parenthesis	(
, (Comma)	,) (Right parenthesis)
' (Apostrophe)	'	<	<
? (Question mark)	?	>	>
! (Exclamation mark)	!	[[
&	&]]
@	@	{	{
\$	\$	}	}
~ (Tilde)	~	+	+
/ (Slash)	/	-	-
\ (Back slash)	\	*	*
"	"	÷	÷
;	;	=	=
:	:	#	#
_	_	%	%
		^	^
'	'	`	`
'	'	™	™
“	“	®	®
”	”	©	©

Continued on next page

Using Graffiti® 2 writing to enter text

§		ı	
•		°	
¢		β	
€		μ	
¥		f	
£		∅	
ı		ç	

Writing accented letters

To enter an accented letter, first write the lower case letter or upper case letter, then write the accent stroke on the Number area of the Graffiti® 2 writing area.

- For details, refer to the following and Graffiti 2 Help on your CLIÉ handheld.

à è ì ò ù		á é í ó ú ý	
â ê î ô û		ã õ ñ	
ä ï ö ü ÿ		å	

Entering text

To enter text, you will need software (an application) that is compatible with your CLIE handheld. Follow the steps below to enter text using **Date Book**.

- 1 Select  (Date Book) on the CLIE Launcher, and then tap it or press the Jog Dial™ navigator.

Date Book starts and today's schedule is displayed.

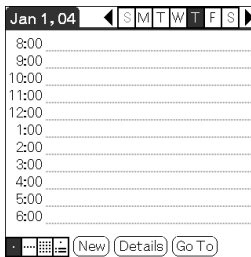

- 2 Tap the time line in the **Date Book** screen.

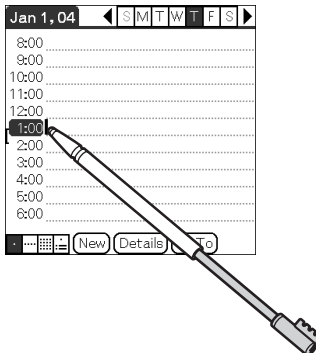

Continued on next page

- 3 Use the tables on the previous pages to find the stroke shape for the letter you want to create. There are several different stroke shapes available for some letters. For those letters, choose the one that is easier for you. Use the same shape to create both the upper case and lower case version of a letter.

- 4 Position the stylus on the Lower case letter area of the Graffiti® 2 writing area. Start your stroke at the dot and draw the stroke shape as it is displayed in the tables.

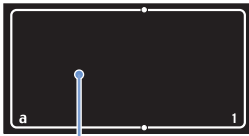

Position the stylus

Note

You must begin the character strokes in the Graffiti® 2 writing area. If you do not make Graffiti® 2 strokes in the Graffiti® 2 writing area, your CLIE handheld does not recognize them as text characters.







Notes on writing Graffiti® 2 characters

- Recognition accuracy improves when you write large strokes. You should draw strokes that nearly fill the Graffiti® 2 writing area.
- Write at natural speed. Writing too slowly can generate recognition errors.
- Do not write on a slant. Vertical strokes should be parallel to the sides of the Graffiti® 2 writing area.

Using navigation strokes and shortcuts

Using navigation strokes

When you are entering text or operating an application, you can use navigation strokes within the field of the application. For details, refer to the following and Graffiti 2 Help on your CLIÉ handheld.

Back Space		Punctuation Shift	
Cut		Copy	
Paste		Undo	
Menu Command*			





*Certain function icons, such as Copy and Delete, will display only when that function is available.

Note

If the letter “L” is registered as a menu command for an application, the letters “K”, “T”, “I”, and “X” will not work as menu commands. This is because the first stroke of these two-stroke letters will be mistakenly recognized as the command “L”. If there is no command “L,” any or all of the four letters can be registered as menu commands.

Continued on next page

Using shortcuts

Default shortcuts are registered on your CLIÉ handheld. To use a shortcut, write the shortcut stroke  followed by the shortcut characters. When you write the shortcut stroke, the Short Cut Shift indicator is displayed at the insertion point to show that you are in Shortcut mode. For example, if you write the Graffiti® 2 writer shortcut “ds” (, , and ) in the Graffiti® 2 writing area, this enters the current date and time. For details, refer to the following.

The following are the Graffiti® 2 Shortcuts that are registered on your CLIÉ handheld:

Date stamp	ds	Breakfast	br
Time stamp	ts	Lunch	lu
Date/time stamps	dts	Dinner	di
Meeting	me		

Tips

- You can also enter shortcuts by using Symbol mode.
- You can also create your own shortcuts. For details, refer to “Customizing your CLIÉ™ handheld (Preferences): Creating Graffiti® 2 ShortCuts” on page 80.

Using Decuma Input to enter text (for PEG-TJ37 only)

Decuma Input converts your handwriting into typed text and can be used to input text with any application. Simply write in the input area. The interpretation of your handwriting is displayed in the same place you write.

Entering text

To enter text, you will need software (an application) that is compatible with your CLIÉ handheld. Follow the steps below to practice entering text using **Date Book**.

- 1 Select  (Date Book) on the CLIE Launcher, and then tap it or press the Jog Dial™ navigator.

Date Book starts and today's schedule is displayed.

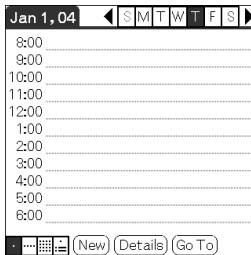

Continued on next page

2 Tap the time line on the **Date Book** screen.

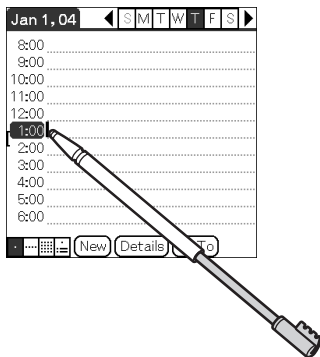

3 Tap “a” on the Graffiti 2 input area.

The **Decuma Latin** screen is displayed.

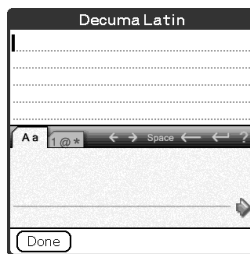

Tip

You can also display the **Decuma Latin** screen by tapping “1” on the Graffiti 2 input area. In this case, the **Decuma Latin** screen for Numbers and Special characters is displayed.

For details, refer to “The areas for writing letters and numbers are different” on page 63.

Continued on next page

4 Write on the baseline of the input area.

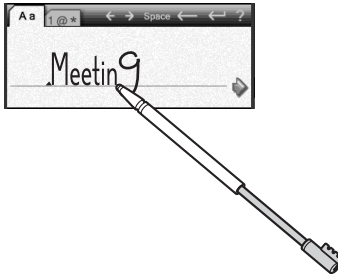

Tip

Write as you normally would.

5 Tap **▶** at the end of the baseline.

The typed text is inserted in the top of the **Decuma Latin** screen.



6 Tap [Done].

The typed text is inserted in the **Date Book** screen.

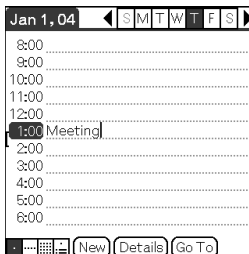

Continued on next page

The areas for writing letters and numbers are different

Your handwriting can be recognized in two different modes: as general characters, and as numbers and special characters.



General characters mode



Numbers and special characters mode

Other input operations

←, →: Moves the cursor

space: Inserts a space

↵: Deletes the last character

↵: Starts a new line behind the cursor

?: Displays the **Decuma Latin** help screen

Tip

You can drag the stylus to the top of the screen from the Graffiti® 2 writing area when **Decuma Latin** screen is displayed, to display the **Decuma Latin** help screen.

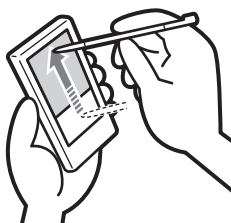

Changing the Decuma Input settings

- 1 Select  (Decuma) on the CLIE Launcher, and then tap it or press the Jog Dial™ navigator. The **Decuma** screen is displayed.

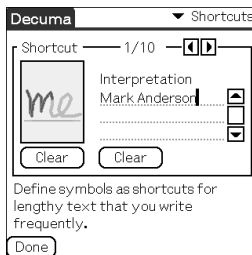

- 2 Tap ▼ at the top right of the screen, and select the desired settings.

[Shortcuts]

Defines shortcuts for lengthy text that you write frequently.

[Personalize]

Edits the Decuma alphabet to adjust individual characters for improved recognition.

[Settings]

Customizes Decuma Input's features.

[Info]

Displays the version of Decuma Input on your CLIE™ handheld.

Using the on-screen keyboard to enter text

You can enter text using the stylus of your CLIÉ handheld.

Entering text

To enter text, you will need software (an application) that is compatible with your CLIÉ handheld. Follow the steps below to practice entering text using **Date Book**.

- 1 Select  (Date Book) on the CLIE Launcher, and then tap it or press the Jog Dial™ navigator.

Date Book starts and today's schedule is displayed.

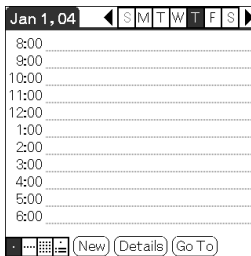

- 2 Tap the time line on the **Date Book** screen.

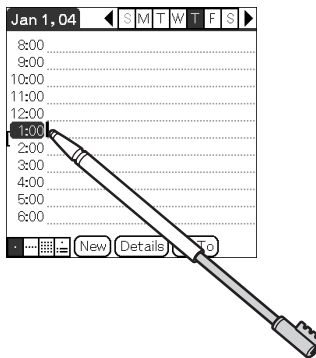

Continued on next page

3 Tap  (Menu).

The menu is displayed.

4 Tap [Edit], and select [Keyboard].

The **keyboard** screen is displayed.

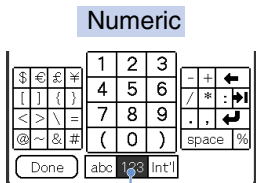
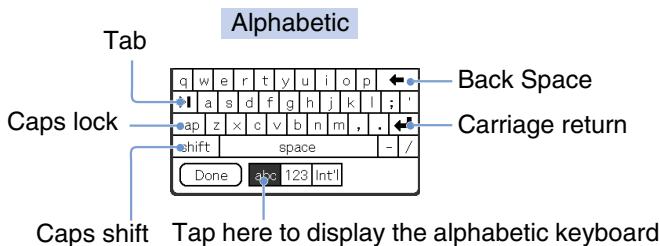

Tap here to display the numeric keyboard



Tap here to display the international keyboard

5 Select the required keyboard and tap the characters to enter text and numbers.

You can use the on-screen keyboard in the same way as your computer's keyboard. To enter a capital letter, tap "cap" and then tap the character button. To delete a character, tap .

6 When you have finished entering the text, tap [Done].

The keyboard screen is closed, and the typed text is inserted in the **Date Book** screen.

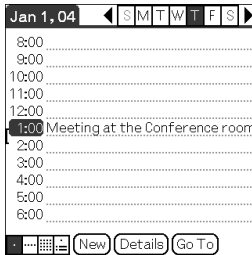



Exchanging and updating files/data using the HotSync[®] operation

This chapter explains how to perform the HotSync[®] operation with your computer.

What is the HotSync[®] operation?	69
Performing the HotSync[®] operation	71
Using Palm[™] Desktop for CLIÉ	73

What is the HotSync[®] operation?

The HotSync[®] operation is an easy operation that allows you to synchronize files/data between your CLIÉ handheld and computer. With just one press of the HotSync button, you can synchronize your CLIÉ handheld application files/data with **Palm™ Desktop for CLIÉ** files/data on your computer, back up the files/data of your CLIÉ handheld on your computer, and install add-on applications.

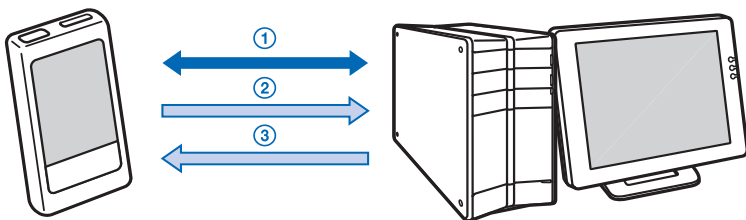

① Synchronizing the files/data between your CLIÉ handheld and computer

Synchronizes the data of **Date Book, Address Book, To Do List, and Memo Pad** between your CLIÉ handheld and computer. You can manage the files/data of multiple CLIÉ handhelds separately using **Palm™ Desktop for CLIÉ**.

② Saving backup data or applications on your computer

Automatically creates a backup of the data or applications currently held on your CLIÉ handheld to your computer. If you delete data or applications by accident, or if you need to perform a hard reset, the HotSync[®] operation allows you to restore the data or applications using the backup data or applications on your computer.

You may not be able to create a backup of certain contents by the HotSync[®] operation.

For details on backing up data and applications, refer to page 167.

Continued on next page

Tip

You can save a backup of the data or applications currently held on your CLIÉ handheld into “Memory Stick” media. For details, refer to “Backing up data and applications to “Memory Stick” media using Memory Stick Backup” (page 168).

③ Using the files/data created in Microsoft® Windows® applications on your CLIÉ handheld

Imports or exports the files/data between a Windows software on your computer and CLIÉ handheld.

The compatible file formats that you can import/export to the Palm™ Desktop for CLIÉ

- Comma/Tab delimited (*.csv, *.txt, *.tab, *.tsv)
- Text file (*.txt)
- vCal (Date Book) file (*.vcs)
- vCard (Address) file (*.vcf)
- Date Book archive of **Palm™ Desktop for CLIÉ** (*.dba)
- Address Book archive of **Palm™ Desktop for CLIÉ** (*.aba)
- To Do List archive of **Palm™ Desktop for CLIÉ** (*.tda)
- Memo Pad archive of **Palm™ Desktop for CLIÉ** (*.mpa)

* The words in parentheses are file extensions. Archive is a unit that gathers associated files.

- ➔ For details on importing/exporting files/data, refer to the online help of **Palm™ Desktop for CLIÉ**.

Performing the HotSync[®] operation

To perform the HotSync[®] operation, **Palm™ Desktop for CLIÉ** must be installed on your computer.

- ➔ For details on the HotSync[®] operation, refer to “Using your CLIÉ™ handheld with your computer” in the “Read This First (Operating Instructions)”.

Performing the HotSync[®] operation with the USB cable (Local HotSync[®])

Performing the HotSync[®] operation with the USB cable supplied with your CLIÉ handheld is called the Local HotSync[®] operation.

1 Connect your CLIÉ handheld to your computer with the USB cable supplied with your CLIÉ handheld.

2 Tap  (Home).
The CLIE Launcher is displayed.

3 Rotate the Jog Dial™ navigator to select  (HotSync), and then press the Jog Dial™ navigator.
The **HotSync** screen is displayed.

Tip

You can tap  (HotSync) on the CLIE Launcher to display the **HotSync** screen.

4 Tap  (HotSync).
The HotSync[®] operation starts.

Continued on next page

Performing the HotSync® operation



When the HotSync® operation is complete, a message showing the HotSync® completion is displayed on your CLIE handheld.

Note

Do not disconnect your CLIE handheld from your computer until the HotSync® operation is complete. Also, do not insert or remove the “Memory Stick” media while the HotSync® operation is being performed. Otherwise, **Palm™ Desktop for CLIE** may not finish normally.

If the HotSync® operation does not start

Make sure that  (HotSync) is displayed in the Windows task tray (Notification area**).

If  (HotSync) is not displayed in the task tray (Notification area), click [Start], select [Programs] ([All Programs] for Windows XP*) - [Sony Handheld], and click [HotSync Manager]. Check that  (HotSync) is displayed in the task tray (Notification area) and tap  (HotSync) on the screen of your CLIE handheld to start the HotSync® operation.

The message is displayed on your computer window when the HotSync® operation starts.

* From this point onwards, where Windows XP Home Edition and Windows XP Professional are common, they will both be referred to as Windows XP.

**In Windows XP, the task tray is called “Notification area”.

In this manual, it is written as “task tray (Notification area)”.

Tip

If you cannot perform the HotSync® operation

Refer to the “Troubleshooting Q&A” (PDF format).

Using Palm™ Desktop for CLIÉ

Palm™ Desktop for CLIÉ enables you to view the data transferred from your CLIÉ handheld by the HotSync® operation, on your computer.

Additionally, **Palm™ Desktop for CLIÉ** has the same functions as **Date Book**, **Address Book**, **To Do List**, and **Memo Pad** so that you can enter or modify schedules or address book data on your computer and export data to your CLIÉ handheld.

Starting Palm™ Desktop for CLIÉ

- 1 Double-click  (Palm Desktop for CLIÉ) on the Windows desktop.
You can also click [Start], select [Programs] ([All Programs] for Windows XP) - [Sony Handheld], and click [Palm Desktop for CLIÉ].
Palm™ Desktop for CLIÉ starts.

Tip

To quit Palm™ Desktop for CLIÉ

Click  at the top right of the window or select [Exit] from [File].

Locating components of Palm™ Desktop for CLIÉ

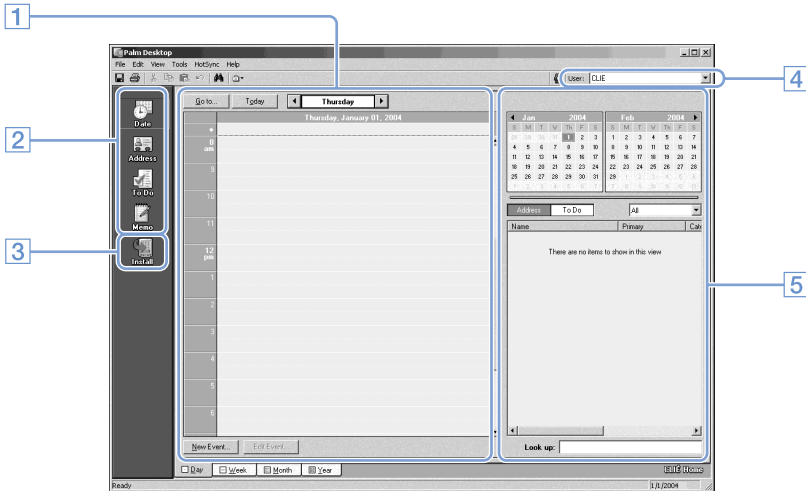

1 List pane

Displays the records in the current Desktop application.

2 Application Launch bar

Click an icon to open the associated application.

3 Install icon

Click this icon to display the **Install Tool** window. You can install applications onto your CLIÉ handheld with the HotSync® operation.

➔ For details, refer to “Installing” on page 182.

4 User selector

Displays the user name of the current information.

5 Record pane

Displays full details of the record that is selected in the List pane. The information displayed here is the same as what is displayed when you tap [Details] on your CLIÉ handheld applications, such as **Date book**.

Basic operations of Palm™ Desktop for CLIÉ

Click the icon of the application you want to use. The window switches to the selected application window.

Basic operations for each application are the same as those of the corresponding CLIÉ handheld application.

- ➔ For details on operations, refer to the online help of **Palm™ Desktop for CLIÉ**. To display the online help, select [Palm™ Desktop Help] from [HELP].

Tip

Changing the user name of your CLIÉ handheld

- ① **In the Palm™ Desktop for CLIÉ window, click [Users] from [Tools].**
The **Users** dialog box is displayed.
- ② **Click the user name you want to change and click [Rename].**
- ③ **Enter a new user name and click [OK].**
Your CLIÉ handheld user name is changed at the next HotSync® operation.

When using the Microsoft® Windows® XP operating system

When you start **Palm™ Desktop for CLIÉ** on your computer, and select [Custom], [File Link], [View Log], or [Setup] from [HotSync], the configuration window may open behind the **Palm™ Desktop for CLIÉ** window.

In this case, bring the configuration window to the front by performing one of the following:

- Press the Alt and Tab keys at the same time.
- Click  (HotSync) at the bottom right of the Windows task tray (Notification area).

Customizing your CLIE™ handheld (Preferences)

This chapter explains how to customize your CLIE handheld by changing the Preferences settings.

What you can do with Preferences	77
Setting the Graffiti® 2	79
Creating Graffiti® 2 ShortCuts	80
Viewing the battery information and media information, and changing the volume level	81
Adjusting the Digitizer	82
Setting the Network preferences for a wireless LAN (for PEG-TJ37 only)	83
Setting the Network preferences for your provider and dial-up server	88
Assigning applications to application buttons	99
Customizing the full-screen pen stroke activities	100
Setting the automatic power-off time	101
Setting sounds	102
Turning the Alarm LED on or off	103
Turning the Beam Receive feature on or off	104
Selecting the screen color theme	105
Setting the display format for time, date, and numbers	106
Adding/Changing communication device preferences	107
Setting up the Date & Time preferences	108

What you can do with Preferences

The **Preferences** screen enables you to customize the configuration options on your CLIÉ handheld.

Setting options may be added by installing new applications or software for peripheral devices.

Settings	Details
Buttons	Customizes applications assigned to application buttons, and the full-screen pen stroke operation. ➔ For details, refer to pages 99 to 100.
Connection	Sets the configuration for the communication device. ➔ For details, refer to page 107.
Date & Time	Sets the current date, time, time zone and daylight saving configuration. ➔ For details, refer to page 108.
Digitizer	Calibrates the screen of your CLIÉ handheld. ➔ For details, refer to page 82.
Formats	Sets the formats for time, date, or numbers. ➔ For details, refer to page 106.
General	Sets the configurations for auto shut-off interval, system sound, LED feature, and display color theme. ➔ For details, refer to pages 101 to 105.
Graffiti 2	Sets alternate forms of writing the characters T, P, Y, and \$. ➔ For details, refer to page 79.
Network	Sets the Internet connection configuration. ➔ For details, refer to page 88.
Owner	Sets the owner information, such as name and phone number. ➔ For details, refer to page 172.
ShortCuts	Defines a list of Graffiti [®] 2 abbreviations. ➔ For details, refer to page 80.
StatusInfo	Displays the battery information and media information. And adjusts the volume level. ➔ For details, refer to page 81.

Continued on next page

Displaying the Preferences screen for each menu

- 1 Rotate the Jog Dial™ navigator to select  (Prefs) on the CLIE Launcher and press the Jog Dial™ navigator. The **Preferences** screen is displayed.

Tip

You can also tap  (Prefs) to display the **Preferences** screen.

- 2 Tap ▼ at the top right of the screen, and select the Preferences menu you want to configure.

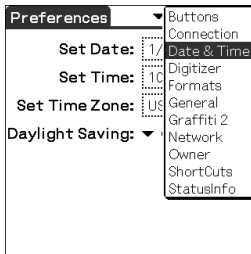

Setting the Graffiti® 2

You can select alternate forms of writing the characters T, P, Y, and \$ on your CLIÉ handheld.

For example, to select an alternate way to write the character T:

- 1** Tap ▼ at the top right of the **Preferences** screen, and select [Graffiti 2].
- 2** Tap [t].
The **Graffiti 2 Tuner** dialog box is displayed.
- 3** To confirm the displayed method of writing the letter T, tap next to [Use this form of 't'.] to change to .
- 4** Tap [Done].

Tip

You can also change the way you write the character P, Y, and \$ in the same way.

Note

When an alternate method of writing the selected character is selected, your CLIÉ handheld will not recognize the default method of writing that character.

Creating Graffiti® 2 ShortCuts

You can create abbreviations (ShortCuts) for entering text with Graffiti® 2 strokes.

➔ For details on using Graffiti® 2 ShortCuts, refer to “Using shortcuts” on page 59.

- 1** Tap ▼ at the top right of the **Preferences** screen, and select [ShortCuts].
- 2** Tap [New].
The **ShortCut Entry** dialog box is displayed.
- 3** Enter the new ShortCut name and ShortCut text for [ShortCut Name:] (abbreviation) and [ShortCut Text:] (character string).
- 4** Tap [OK].
The new ShortCut is created and the list of ShortCuts is displayed.

To Edit a ShortCut

- 1** Tap the ShortCut you want to edit and tap [Edit].
- 2** Edit the ShortCut name and ShortCut text for [ShortCut Name:] (abbreviation) and [ShortCut Text:] (character string) and tap [OK].

To Delete a ShortCut

- 1** Tap the ShortCut you want to delete and tap [Delete...].
The **Delete** dialog box is displayed.
- 2** Tap [Yes].
The selected ShortCut is deleted.

Viewing the battery information and media information, and changing the volume level

You can check the remaining battery power and media conditions, and change the volume level for audio, system, alarm, and game-sound.

- For details, refer to “CLIE™ handheld components: Locating the components of the CLIE Launcher” in the “Read This First (Operating Instructions).”

1 Tap ▼ at the top right of the **Preferences** screen and select [StatusInfo].

The **Preferences** screen for [StatusInfo] is displayed.

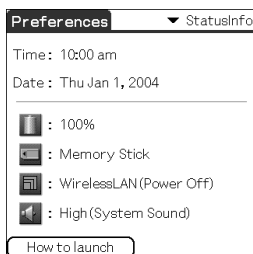

2 Tap the appropriate icon to change or view the status.

A dialog box is displayed.

: displays the **Battery Information** screen.

: displays the **Media Info** screen.

: displays the **Wireless Info** screen (for PEG-TJ37 only).

: displays the **Adjust Volume** screen.

- For details on displaying each screen, refer to “CLIE™ handheld components: Locating the components of the CLIE Launcher” in the “Read This First (Operating Instructions).”

Adjusting the Digitizer

You need to adjust the digitizer when performing a hard reset, when the tapping operation or scrolling does not work properly, or when you cannot adjust the brightness of the backlight or screen contrast.

- 1 Tap ▼ at the top right of the **Preferences** screen, and select [Digitizer].

The Digitizer calibration screen is displayed.

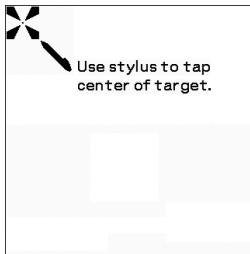

This Digitizer calibration screen is the same as the screen displayed when the first time you turned on your CLIÉ handheld. Follow the on-screen instructions to adjust the digitizer.

Tip

Use the stylus perpendicularly to the screen to tap targets.

Setting the Network preferences for a wireless LAN (for PEG-TJ37 only)

Setting a wireless LAN access point manually

- 1 Tap ▼ at the top right corner of the **Preferences** screen, and select [Network].
- 2 Tap [▼ Service:], and select [Wireless LAN].
- 3 Tap [Details...].
The **Wireless LAN Setup** screen is displayed.
- 4 Tap [Create].
- 5 Enter the profile name into [ProfileName :].
- 6 Enter the SSID into [SSID :].
- 7 Tap [▼ None] under [WEP :], then select the type of WEP key.
The **WEP KEY Input** dialog box is displayed.
- 8 Enter WEP Key, then tap [OK].
The **WEP KEY Input** dialog box is closed.
- 9 Tap [Infrastructure] or [Adhoc] to select the connecting mode.
Your CLIÉ handheld can communicate directly with other wireless LAN compatible devices without using a wireless LAN access point.
To use a wireless LAN communication in this mode, tap [Adhoc]. Then, tap [▼ 1ch], and select the channel number to use for the wireless LAN communication.
To use a wireless LAN communication via a wireless LAN access point, tap [Infrastructure]. when your CLIÉ handheld is set up to connect to a wireless LAN access point automatically (refer to P.86), this setup is treated as one for selection. Auto Connect is enabled by default. To cancel Auto Connect, tap next to [AutoConnect:] to change to .

Continued on next page

10 Perform the following procedures if necessary by tapping [Advanced Setup]:

- **IP address:**

DHCP (Dynamic Host Configuration Protocol) is enabled by default. When DHCP is cancelled, and you can manually set up an IP Address, Subnet mask, Gateway Address, Primary DNS, and Secondary DNS. To cancel DHCP, tap next to [IP Address:] to change to .

- **DNS Address:**

You can manually set up a Primary DNS and Secondary DNS. To cancel DNS Address automatical setup, tap next to [DNS Address:] to change to .

- **PowerSaveMode:**

The Power Save function is enabled by default. If the communication reception of the wireless LAN is low, disable the Power Save function and communicate with the maximum power. In this case, the battery of your CLIÉ handheld will run out quickly. Enable Power Save function for normal use. To disable the Power Save function, tap next to [PowerSaveMode:] to change to .

- **Authentication:**

When any option other than [▼ None] is selected in step 7, you can select [Open System] or [Shared KEY] for the Authentication of the wireless LAN access point you want to connect to. [Open System] is selected by default.

11 Tap [OK] twice.

The **Wireless LAN Setup** screen which added [*NewProfile] under [Profile Name :] is displayed.

12 Tap [OK].

The **Wireless LAN Setup** screen is closed, and the **Preferences** screen for [Network] is displayed.

..... Searching and setting a wireless LAN access point manually

- 1** Tap ▼ at the top right corner of the **Preferences** screen, and select [Network].
 - 2** Tap [▼ Service:], and select [Wireless LAN].
 - 3** Tap [Details...].
The **Wireless LAN Setup** screen is displayed.
 - 4** Tap [Scan].
The **Connection Progress** dialog box is displayed until a wireless LAN access point is found at least. When wireless LAN access point(s) is(are) found, it(they) is(are) displayed on the **ScanResult** screen.
- Tip**
- The existing wireless LAN access point may be not detected via Scan operation because of an electric wave condition or timing. Moreover, profile may be set to be hidden at the wireless LAN access point side. In this case, your CLIÉ handheld also can not detect it.
- 5** Tap one from the found wireless LAN access points, then tap [Select].
The **Wireless LAN Setup** screen is displayed.
 - 6** Tap [▼ None] under [WEP :], then select the type of WEP key.
The **WEP KEY Input** dialog box is displayed.
 - 7** Enter the WEP Key, then tap [OK].
The **WEP KEY Input** dialog box is closed.
 - 8** Tap [OK].
The **Wireless LAN Setup** screen which added new SSID setting for the selected wireless LAN access point under [Profile Name :] is displayed.
 - 9** Tap [OK].
The **Wireless LAN Setup** screen is closed, and the **Preferences** screen for [Network] is displayed.

..... **Connecting your CLIÉ handheld to a wireless LAN access point automatically**

You can enable the Auto Connect function at the setting of more than one wireless LAN access point. In this case, the most suitable wireless LAN access point is selected.

Tip

To connect your CLIÉ handheld to a wireless LAN access point automatically, enable the Auto Connect function (refer to P.83) by tapping (check box) next to [Auto Connect:] at the setting of wireless LAN access point. When the Auto Connect function is enabled for a wireless LAN access point, “*” is indicated at the left side of the SSID of the wireless LAN access point on the **Wireless LAN setup** screen.

- 1** Tap ▼ at the top right corner of the **Preferences** screen, and select [Network].
- 2** Tap [▼ Service:], and select [Wireless LAN].
- 3** Tap [Details...].
The **Wireless LAN Setup** screen is displayed.
- 4** Tap [-Auto Connect-] under [Profile Name:].
- 5** Tap [OK].
The **Wireless LAN Setup** screen is closed and the **Preferences** screen for [Network] is displayed.

..... Checking the wireless LAN communication status

Tip

If you need a MAC address, check [MAC Address:] in the **Connect Setting** screen by the following method.

- 1 Tap ▼ at the top right corner of the **Preferences** screen, and select [Network].
The **Preferences** screen for [Network] is displayed.
- 2 Tap [▼ Service:], and select [Wireless LAN].
- 3 Tap [Details...].
The **Wireless LAN Setup** screen is displayed.
- 4 Tap  (Menu).
The **Information** menu is displayed.
- 5 Tap [ConnectionStatus...].
The **Connect Setting** screen is displayed.
To return to the **Wireless LAN Setup** screen, tap [OK].

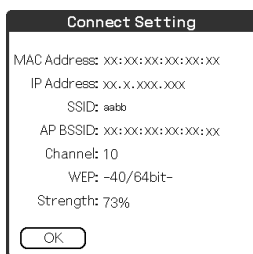

Tip

If a MAC address is not displayed, tap [Connect] after step 2 and continue step 3.

Setting the Network preferences for your provider and dial-up server

Note

For the settings specific to a peripheral device, refer to the manual of that device.

Selecting a service template

You can customize the Service setting to select the service template for your Internet Service Provider or a dial-up server.

- 1 Tap ▼ at the top right of the **Preferences** screen, and select [Network].
The **Preferences** screen for [Network] is displayed.
- 2 Tap [▼ Service:], and select the service template (**Internet Service Provider name**) you want to use.

Tips

- To add a new service template, select [New] from [Service] by tapping  (Menu). If the Internet Service Provider name you want to use is not displayed in the list, tap [▼ Service:], or select [New] from [Service], and enter the new Internet Service Provider name.
You can create multiple service templates for your Internet Service Provider. You should name them so that those service templates are uniquely identified, such as “So-net1” and “So-net2”. This is useful when using your Internet Service Provider by access point. It is also useful when setting the service template.
- If you want to copy an existing service template without changing, select [Duplicate] from [Service].

Entering a user name

The User Name setting identifies the name you use when you log into your Internet Service Provider (ISP) or dial-up server.

- 1 Tap next to [User Name:] on the **Preferences** screen for [Network].
- 2 Enter your user name.

Notes

- Although this field can contain multiple lines of text, only two lines are displayed on the screen at a time.
- Most dial-up servers do not accept spaces in the user name.

..... **Entering a password**

The Password setting identifies the password you use to log into your server or ISP. Your entry in this field determines whether your CLIÉ handheld prompts you to enter a password each time you log into your network:

- If you do not enter a password, your CLIÉ handheld displays the word [-Prompt-] in this field and asks you to enter a password during the log-in procedure.
- If you enter a password, your CLIÉ handheld displays the word [-Assigned-] in this field and does not prompt you to enter a password during the log-in procedure.

Note

If you are concerned about security, select [-Prompt-] and do not enter a password.

- 1** Tap next to [Password:] on the **Preferences** screen for [Network].
The **Password** dialog box is displayed.
- 2** Enter the password you use to log into your server.
- 3** Tap [OK].
The field for [Password:] changes to display the word [-Assigned-].

..... **Selecting a connection**

Use the Connection setting to select the method you want to use to connect to your Internet Service Provider (ISP) or a dial-up server.

- 1** Tap ▼ next to [Connection:], and select [Standard Modem] on the **Preferences** screen for [Network].

Setting the telephone information

Define the telephone number you use to connect to your ISP or dial-up server. In addition, you can also define a prefix, disable Call Waiting, and use a calling card.

Note

The calling card option works correctly only for AT&T and Sprint long distance services. If you want to call by MCI, you need to set your telephone information by entering the calling card number in the field for [Phone #:] and the phone number in the field for [Use calling card:].

- 1 Tap next to [Phone:] on the **Preferences** screen for [Network].
The **Phone Setup** screen is displayed.
- 2 Enter the phone number for your ISP or dial-up server in the field for [Phone #:].
- 3 Define the following settings if necessary:

Dial prefix:

Enter the dial prefix (e.g., “9”) to call an outside line.

- 1 Tap next to [Dial prefix:] to change to .

Enter the dial prefix (e.g., “9,”) in the field next to [Dial prefix:].

Disable call waiting:

When you contract a call-waiting service with your telephone communication company, you have to interrupt the call-waiting function while accessing the Internet. Ask your telephone communication company about the code to interrupt the call-waiting function.

- 1 Tap next to [Disable call waiting:] to change to .

- 2 Enter the code to interrupt the call-waiting function (e.g., “1170,”) in the field next to [Disable call waiting:].

Use calling card:

This option is valid in the USA only.

You can access the Internet using a calling card.

Continued on next page

Setting the Network preferences for your provider and dial-up server

Note

The calling card option works correctly only for AT&T and Sprint long distance services. If you want to call by MCI, you need to set your telephone information by entering the calling card number in the field for [Phone #:] and the phone number in the field for [Use calling card:].

- ① Tap next to [Use calling card:] to change to .
- ② Enter your calling card number (e.g., “,,,,123456...”) in the field next to [Use calling card:].

Tip

Usually, waiting time is needed before entering a calling card number. When you enter your calling card number, insert at least three commas before your calling card number for rectifying the waiting time (transmission of a calling card number delays for 2 seconds per one comma).

4 Tap [OK].

The **Preferences** screen for [Network] is displayed.

..... Adding detailed information to a service template

If you are using one of the predefined service templates, you probably only need to enter your user name and telephone number. If you are creating a new service template, you may need to provide additional information to your ISP or dial-up server. Use the **Details** screen to add additional information to a selected service template.

- 1** Tap [▼ Service:] on the **Preferences** screen for [Network], and select the service template (**Internet Service Provider name**) you want to add detailed information.
- 2** Tap [Details...].
The **Details** screen is displayed.
- 3** Tap ▼ next to [Connection type:], and select one of the following connection types.
 - **PPP:**
Point-to-Point Protocol
 - **SLIP:**
Serial Line Internet Protocol
 - **CSLIP:**
Compressed Serial Line Internet Protocol

Tip

If you are not sure, try PPP; if that does not work, ask your Internet Service Provider (ISP) or your System Administrator for the correct connection type.

Continued on next page
.....

- 4** Tap next to [Idle timeout:], and select one of the following options.
 - **1 Minute:**
Waits one minute before dropping the connection when you open another application that does not use the network.
 - **2 Minutes:**
Waits two minutes.
 - **3 Minutes:**
Waits three minutes.
 - **Never:**
Keeps your PPP or SLIP connection open until you turn off your CLIÉ handheld (or until it times out). Note that this option will be more costly than others.

- 5** Tap next to [Query DNS:] to deselect it.

- 6** Enter the IP address for [Primary and Secondary DNS:] (Domain Naming System).
Ask your ISP or System Administrator for the correct Primary or Secondary DNS IP numbers.

- 7** If you need to enter your CLIÉ handheld's IP Address, tap next to [IP Address:] to display a permanent IP address field beneath the check box.
Normally, you do not need to enter this IP address. If you are not sure, select Automatic and go to step 9.

- 8** Enter your CLIÉ handheld's IP Address.

- 9** Tap [OK].

..... **Duplicating/deleting additional service templates**

You can create additional service templates from scratch or by duplicating existing templates and editing the information. After you create a new or duplicate template, you can add and edit settings.

Duplicating an existing service template

- 1** Tap [▼ Service:] on the **Preferences** screen for [Network], and select the service template you want to duplicate.
- 2** Tap  (Menu).
The menu is displayed.
- 3** Tap [Duplicate] from [Service].
A copy of the service template (**The name of an original service template + Copy**) is added to the drop-down list for the Service field.

Deleting a service template

You can delete an existing service template.

- 1** Tap [▼ Service:] on the **Preferences** screen for [Network], and select the service template you want to delete.
- 2** Tap  (Menu).
The menu is displayed.
- 3** Tap [Delete...] from [Service].
The **Delete Service** dialog box is displayed.
- 4** Tap [OK].
The selected service template is deleted.
To cancel deleting, tap [Cancel].

..... **Creating log-in scripts**

A log-in script is a series of commands that automates logging in to a network server, such as your corporate network or your Internet Service Provider (ISP). You can also use non-ASCII characters or literal characters for Log-in Scripts.
➔ For details, refer to “Non-ASCII Characters for Log-in Scripts” on page 97.

- 1** Tap ▼ at the top right of the **Preferences** screen, and select [Network].
- 2** Tap [▼ Service:] on the **Preferences** screen for [Network], and select the predefined service template you want to create log-in scripts.
- 3** Tap [Details...].
The **Details** screen is displayed.
- 4** Tap [Script...].
The **Log in Script** screen is displayed.
- 5** Tap [▼ End:], and select one of the following commands.
If the command requires additional information, a field is displayed to the right of it for you to enter the information.

Continued on next page
.....

Setting the Network preferences for your provider and dial-up server

Wait For	Makes your CLIÉ handheld wait for specific characters from the TCP/IP server before executing the next command.
Wait For Prompt	Detects a challenge-response prompt coming from the server and displays the dynamically generated challenge value. Then enter the challenge value into your token card, which in turn generates a response value for you to enter on your CLIÉ handheld. This command takes two arguments, separated by a vertical bar () on the input line.
Send	Transmits specific characters to the TCP/IP server to which you are connecting.
Send CR	Transmits a carriage return or LF character to the TCP/IP server to which you are connecting.
Send User ID	Transmits the User ID information entered in the User ID field of the Preferences screen for [Network].
Send Password	Transmits the password entered in the Password field of the Preferences screen for [Network]. If you did not enter a password, this command prompts you to enter one. The Password command is usually followed by a Send CR command.
Delay	Makes your CLIÉ handheld wait a specific number of seconds before executing the next command in the log-in script.
Get IP	Reads an IP address and uses it as the IP address for your CLIÉ handheld. This command is used with SLIP connections.
Prompt	Opens a dialog box and prompts you to enter text (for example, a password or a security code).
End	Identifies the last line in the log-in script.

- 6 Repeat Step 4 until the log-in script is complete.
- 7 Tap [OK].
The **Details** screen is displayed.
- 8 Tap [OK].
The **Preferences** screen for [Network] is displayed.

Continued on next page

Non-ASCII Characters for Log-in Scripts

The following information enables you to create custom log-in scripts that require non-ASCII characters. It is provided for advanced users who understand the use and requirements of such characters in a custom log-in script.

Use of ^char

You may use the caret (^) to transmit ASCII command characters. If you send ^char, and the ASCII value of character is between @ and _, then the character is automatically translated to a single-byte value between 0 and 31.

For example, ^M is converted to a carriage return.

If character is a value between A and Z, then the character sequence is translated to a single-byte value between 1 and 26. If character is any other value, then the character sequence is not subject to any special processing. For example, the string “Joe^M” transmits Joe, followed by a carriage return.

Carriage return and line feed

You may include carriage return and line feed commands as part of the log-in script, when they are entered in the following format.

- **<cr>** : Sends or receives a carriage return
- **<lf>** : Sends or receives a line feed

For example, the string “wait for Joe<cr><lf>” waits to receive Joe followed by a carriage return and line feed from the remote computer, before executing the next command in the script.

Literal characters

The backslash (\) character defines that the next character is transmitted as a literal character, and is not subject to any special processing ordinarily associated with that character.

Examples:

- **\^** : Includes a caret as part of the string
- **\<** : Includes a < as part of the string
- **** : Includes a backslash as part of the string

Using the Network preferences menus

This section describes the menu commands specific to the network preferences. For the menu commands that are common for the CLIÉ handheld applications, refer to “Common menu items” on page 43.

Service menus

[New]	Creates a new service template.
[Delete...]	Deletes the current service template.
[Duplicate]	Duplicates the current service template.

Options menu

[View Log]	Displays the Network Log screen that lists the history of your Internet connection. Tap [Done] to close the Network Log screen.
------------	--

Continued on next page

Assigning applications to application buttons

You can assign your favorite applications to the application buttons on the front panel of your CLIE handheld.

For example, you can assign the Date Book button to start **Calculator**.

► For details, refer to “CLIE™ handheld components” in the “Read This First (Operating Instructions)”.

- 1 Tap ▼ at the top right of the **Preferences** screen, and select [Buttons].

The **Preferences** screen for [Buttons] is displayed.

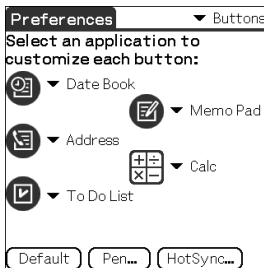

- 2 Tap ▼ next to the icon, and select the application you want to assign.

The application button is changed.

To start the default applications

If you assign another application to a button, you can still start the default application from the CLIE Launcher.

To reset to default settings

Tap [Default] in Step 2.

All application buttons are reset to their factory settings.

Customizing the full-screen pen stroke activities

You can customize the assignment of the full-screen pen stroke.

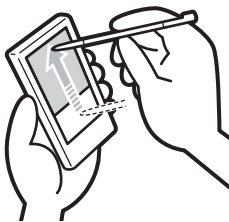

Drag the stylus to the top of the screen from the Silk Screen area.

The full-screen pen stroke will perform the function you assigned to it.

Tip

[Graffiti 2 Help] is set by the default.

Note

When **CLIE Camera** starts on your CLIE™ handheld, if you drag the stylus to the top of the screen from the Silk Screen area (the full-screen pen stroke, which normally brings the **Graffiti 2 help**), the **Status Info** screen may be launched, tap [Done] to close the screen.

- 1 Tap ▼ at the top right of the **Preferences** screen, and select [Buttons].
- 2 Tap [Pen...].
The **Pen** dialog box is displayed.
- 3 Tap [▼ Graffiti 2 Help], and select the settings for the full-screen pen stroke.

Backlight	Turns on the backlight of your CLIE™ handheld without using the POWER button.
Brightness	Opens the Adjust Brightness dialog box.
Keyboard	Opens the on-screen keyboard for entering text.
Graffiti 2 Help	Opens a series of screens that show the complete Graffiti 2 character set.
Turn Off & Lock	Turns off and locks your CLIE™ handheld. To turn on your CLIE™ handheld when it is locked, you must enter a password. ➔ For details, refer to “Protecting your data with a password” (page 171).
Beam Data	Beams the current record to another Palm OS PDA.

- 4 Tap [OK].

Setting the automatic power-off time

Your CLIÉ handheld has an automatic power-off feature that turns off after a period of inactivity to conserve your CLIÉ handheld battery.

You can adjust the time setting for the automatic power-off feature.

By default, your CLIÉ handheld will turn off after two minutes of inactivity and will remain on when connected to the AC power adapter with plug adapter.

1 Tap ▼ at the top right of the **Preferences** screen, and select [General].

The **Preferences** screen for [General] is displayed.

2 Tap ▼ next to [Auto-off After:], and select the desired time.

You can select 30 seconds, 1 minute, 2 minutes, or 3 minutes.

3 If you want to leave your CLIÉ handheld turned on while it is connected to the AC power adapter with plug adapter, tap

(check box) next to [Stay on in Cradle:].

Tips

- [Auto-off After:] is selected [2 minutes] by the default.
- [Stay on in Cradle:] is set to by the default.

Note

If you tap [Auto Lock Handheld:] to lock on the **Security** screen (page 174), the function for [Stay on in Cradle:] is canceled, and the data protection takes priority.

Setting sounds

You can adjust the volume level of the system sounds, alarm sounds, and game sounds, or turn the sound off completely.

- 1** Tap ▼ at the top right of the **Preferences** screen, and select [General].
The **Preferences** screen for [General] is displayed.
- 2** Tap ▼ next to [System Sound:], and select the desired volume level or [Off].
When [System Sound:] is turned off, the chime tones associated with the HotSync® operation are also turned off.
- 3** Tap ▼ next to [Alarm Sound:], and select the desired volume level or [Off].
- 4** Tap ▼ next to [Game Sound:], and select the desired volume level or [Off].
The setting for [Game Sound:] is only applied to the games programmed to respond to this setting.

Turning the Alarm LED on or off

You can set your CLIÉ handheld to flash its LED at a set time. If you turn the Alarm Sound off and turn the Alarm LED on, you can use the alarm feature without disturbing people around you.

- 1** Tap ▼ at the top right of the **Preferences** screen, and select [General].

The **Preferences** screen for [General] is displayed.

- 2** Tap ▼ next to [Alarm LED:], and select [On] or [Off].

Tip

[Alarm LED:] is set to [On] by the default.

Turning the Beam Receive feature on or off

You can turn on or off the Beam Receive feature.

When you turn off the Beam Receive feature, you cannot receive data via beaming. By default, the Beam Receive feature is set to [On] to conserve your CLIÉ handheld battery.

1 Tap ▼ at the top right of the **Preferences** screen, and select [General].

The **Preferences** screen for [General] is displayed.

2 Tap ▼ next to [Beam Receive:], and select [On] or [Off].

- **On:** Enables the Beam Receive feature.
- **Off:** Disables the Beam Receive feature.

Selecting the screen color theme

You can select the screen color theme.

For example, to select the screen color theme, Indigo:

- 1** Tap ▼ at the top right of the **Preferences** screen, and select [General].
The **Preferences** screen for [General] is displayed.
- 2** Tap ▼ next to [Colors:], and tap [Indigo] from the list box.
The screen color theme is changed to Indigo.

Tip

The screen color theme is set to [Original] by default.

Note

This function is not applicable to all applications.

Setting the display format for time, date, and numbers

Selecting a regional default

When you select the region where you use your CLIÉ handheld, the display format for time, date, week start day, and numbers are adjusted to the regional default. For example, in the United Kingdom, time is expressed using a 24-hour clock; in the United States, time is expressed using a 12-hour clock with an AM or PM suffix.

The regional default setting is applied to the display formats of all your CLIÉ handheld applications. However, you can customize your own settings for each unit, such as time or date.

- 1 Tap ▼ at the top right of the **Preferences** screen, and select [Formats].
- 2 Tap ▼ next to [Preset to:], and select a region.

Customizing your own settings

You can customize your own settings for the display formats for time, date, week start day, and numbers. The settings are applied to the display formats of all your CLIÉ handheld applications.

- 1 Tap ▼ at the top right of the **Preferences** screen, and select [Formats].
- 2 Tap ▼ next to [Time:], and select the desired format.
- 3 Tap ▼ next to [Date:], and select the desired format.
- 4 Tap ▼ next to [Week starts:], and select [Sunday] or [Monday].
This setting is applied to the Day, Week, Month, and Agenda views in **Date Book** and all other applications displaying calendars.
- 5 Tap ▼ next to [Numbers:], and select the desired format.

Adding/Changing communication device preferences

You can customize the preference for a communication device to be connected to your CLIÉ handheld. The applications using the communication device will comply with this preference.

1 Tap ▼ at the top right of the **Preferences** screen, and select [Connection].

2 Tap [New...].

3 Enter the connection name in the field for [Name:].
Enter a suitable name.

4 Tap ▼ next to [Connect to:], and select what you connect your CLIÉ handheld to.

5 Tap ▼ next to [Via:], and select what you use to connect your CLIÉ handheld to your computer.

If you select a modem for [Connect to:]

① Tap ▼ next to [Dialing:], and select the type of line you want to use.

The recommended setting is [TouchTone™].

Do not select [Rotary] unless you are sure that the telephone service being used is not [TouchTone™].

② Tap ▼ next to [Volume:], and select the volume of the modem speaker at the time of connection.

③ Tap [Details...].

The **Details** screen is displayed.

④ Tap ▼ next to [Speed:], and select the maximum speed for the transmission between the modem and your CLIÉ handheld.

⑤ Tap ▼ next to [Flow Ctl:], and select the flow control of the modem connection.

The recommended setting is [Automatic].

⑥ Enter the modem initialization command in the field for [Init String:].

By default, it is set to either **AT&FX4** or **ATZ**. If the modem initialization command is not specified on the modem, changes are not required.

⑦ Tap [OK].

6 Tap [OK].

The configuration for the communication device is changed and the **Preferences** screen for [Connection] is displayed.

Setting up the Date & Time preferences

You can set the date, time, time zone, and daylight savings on/off for your CLIÉ handheld. After you set the local date and time of your home base, you can change the displayed time (for example, during business trips) simply by switching the time zones.

Setting the date

- 1 Tap ▼ at the top right of the **Preferences** screen, and select [Date & Time].
The **Preferences** screen for [Date & Time] is displayed.
- 2 Tap the box next to [Set Date:].
The **Set Date** screen is displayed.
- 3 Tap ◀ or ▶ at the top of the screen to set the year.
- 4 Tap the current month.
- 5 Tap the current date.

Setting the time

- 1 Tap ▼ at the top right of the **Preferences** screen, and select [Date & Time].
The **Preferences** screen for [Date & Time] is displayed.
- 2 Tap the box next to [Set Time:].
The **Set Time** dialog box is displayed.
- 3 Tap ▼ or ▲ to set the hour.
- 4 Tap the minute box and tap ▼ or ▲ to set the minute.
- 5 Tap [AM] or [PM].
- 6 Tap [OK].

..... Setting the time zone and daylight saving time

Setting the time zone

- 1** Tap ▼ at the top right of the **Preferences** screen, and select [Date & Time].
The **Preferences** screen for [Date & Time] is displayed.
- 2** Tap the box next to [Set Time Zone:].
The **Set Time Zone** screen is displayed.
- 3** Select the time zone of your region.
- 4** Tap [OK].

Setting the daylight saving time

- 1** Tap ▼ at the top right of the **Preferences** screen, and select [Date & Time].
The **Preferences** screen for [Date & Time] is displayed.
- 2** Tap ▼ next to [Daylight Saving:].
- 3** Tap [On] or [Off].

Exchanging and updating files/data using the HotSync[®] operation (Other HotSync[®] operations)

This chapter explains how to select the HotSync[®] operating options and how to perform the HotSync[®] operation with a USB cable, infrared communications port, or network. Other advanced HotSync[®] operations include how to use file link functions and how to import data from Windows applications.

Customizing HotSync[®] application settings (Conduit)	111
Synchronizing with external data (File Link)	113
Customizing HotSync[®] Manager startup and HotSync[®] setup options	114
Performing the HotSync[®] operation via a wireless LAN (for PEG-TJ37 only)	115
Performing the IR HotSync[®] operation	118
Performing the HotSync[®] operation via a modem	121
Performing the HotSync[®] operation via a network	127
Performing the HotSync[®] operation via LAN (LANSync)	131

Customizing HotSync® application settings (Conduit)

A program handling the data of an application during the HotSync® operation is called a “conduit”.

For each application, you can define a set of options that determine how data is handled during synchronization. By default, the HotSync® operation synchronizes all files/data between your CLIÉ handheld and **Palm™ Desktop for CLIÉ**.

In addition to the conduits for **Date Book, Address Book, To Do List, and Memo Pad, Palm™ Desktop for CLIÉ** offers System and Install conduits. The System conduit backs up the system information stored on your CLIÉ handheld. The Install conduit installs add-on applications to your CLIÉ handheld. You can select them as needed.

- 1 Click  (HotSync) in the Windows task tray (Notification area) at the bottom right of the computer window, and select [Custom...] from the HotSync® Manager menu.

You can also select [Custom...] from the **HotSync** menu of **Palm™ Desktop for CLIÉ**.

The **Custom** window is displayed.

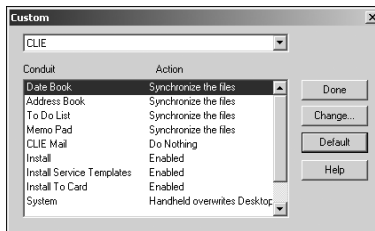

- 2 Select the user name you are using on your CLIÉ handheld from the list at the top.
- 3 Select an application in the Conduit list.

Continued on next page
.....

- 4 Click [Change...].
The **Change HotSync Action** window is displayed.

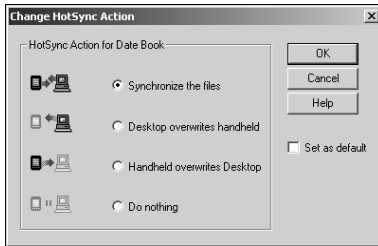

- 5 Click to select one of the following:
 - **Synchronize the files**
 - **Desktop overwrites handheld**
 - **Handheld overwrites Desktop**
 - **Do nothing**
- 6 Click [OK].
- 7 Repeat Steps 2 to 6 to customize conduit settings for other applications (or other users).
- 8 Click [Done].
The conduit setting is changed.

Notes

- The conduit setting is applied only to the next HotSync® operation. Thereafter, the HotSync Actions revert to their default settings. To set a new setting as the default, in Step 5, select the check box for [Set as default].
- To restore the default settings, click [Default] in the **Custom** window.

Synchronizing with external data (File Link)

You can synchronize **Address Book** or **Memo Pad** data in your CLIÉ handheld with external files such as **Address Book** data in your computer (File Link).

HotSync® Manager stores the files in your computer in a separate category on your **Palm™ Desktop for CLIÉ** and your CLIÉ handheld. You can set the File Link feature to start synchronization only when the external file has been updated.

Compatible file formats that you can import with File Link:

- Comma delimited (*.csv)
- Memo Pad archive of **Palm™ Desktop for CLIÉ** (*.mpa)
- Address Book archive of **Palm™ Desktop for CLIÉ** (*.aba)
- Text file (*.txt)

* The words in parentheses are file extensions. Archive is a unit that gathers associated files.

➔ For details on how to set up File Link, refer to the online help of **Palm™ Desktop for CLIÉ**.

Customizing HotSync[®] Manager startup and HotSync[®] setup options



- 1** Click  (HotSync) in the Windows task tray (Notification area) at the bottom right of the computer window, and select [Setup...] from the shortcut menu.
The **Setup** window is displayed.
 - 2** Click [General], and select the setting as needed.
If you are not sure which option to use, select [Always available].
 - **Always available:** Starts **HotSync[®] Manager** when Windows starts. This allows you to perform the HotSync[®] operation even when **Palm[™] Desktop for CLIE** is not running.
 - **Available only when the Palm Desktop is running:** Starts the **HotSync[®] Manager** when you start **Palm[™] Desktop for CLIE**.
 - **Manual:** Starts **HotSync[®] Manager** only when you select [HotSync[®] Manager] from [Start] in Windows.
 - 3** Click [Local] and adjust the setting for the connection between the computer and your CLIE handheld as needed.
 - **Serial port:** Specifies the computer port that is used for the HotSync[®] operation. Make sure that the serial port for the HotSync[®] operation is not shared with the port for modem.
 - **Speed:** Determines the speed at which files/data are transferred. Try the rate, as [As Fast As Possible] first, and adjust downward if you have any problems.
- Note**
- You cannot perform the HotSync[®] operation via a serial port between your CLIE handheld and a computer.
- 4** Click [Modem], and select the setting for the modem as needed.
 - 5** Click [Network], and select the setting for the network as needed.
 - 6** Click [OK] to finish.

Performing the HotSync® operation via a wireless LAN (for PEG-TJ37 only)

To operate the HotSync® operations via a network, you must have network administrator skills.

You can perform the HotSync® operation via a network between your CLIÉ handheld and the computer on the LAN of your office, depending on the network environment of your office. For details, contact the System Administrator of the LAN.

Preparing your computer

- 1 Click  (HotSync) in the Windows task tray (Notification area) at the bottom right of the computer window, and select [Network] from the shortcut menu.
- 2 Click  (HotSync) in the Windows task tray (Notification area) at the bottom right of the computer window once again, and select [Setup...] from the shortcut menu.
The **Setup** window is displayed.
- 3 Click [Network] tab.
- 4 Click the check box next to the user name for HotSync.
- 5 Click [OK].
- 6 Connect your CLIÉ handheld to the computer by a USB cable, and perform the Hotsync® operation by tapping  (HotSync).

The computer information (Primary PC name and Primary PC address (IP address)) is transferred to your CLIÉ handheld.

When you perform the HotSync® operation via a network, your CLIÉ handheld identifies the computer based on the information transferred.

Continued on next page

Preparing your CLIÉ handheld

Follow the steps below to set up your CLIÉ handheld for the HotSync® operation via a network.

- 1 Rotate the Jog Dial™ navigator to select  (HotSync) on the CLIÉ Launcher and press the Jog Dial™ navigator. The **HotSync** screen is displayed.

Tip

You can also tap  (HotSync) to display the **HotSync** screen.

- 2 Tap [Modem].
- 3 Tap  (Menu).
The menu is displayed.
- 4 Tap [Modem Sync Prefs...] from [Options].
The **Modem Sync Preferences** screen is displayed.

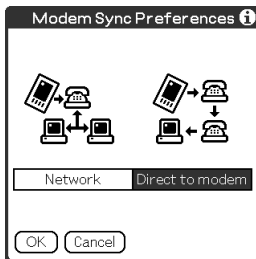

- 5 Tap [Network].
- 6 Tap [OK].
The **HotSync** screen is displayed.
- 7 Tap [Select Service] beneath the icon.
The **Network Preferences** screen is displayed.

Continued on next page

Performing the HotSync® operation via a wireless LAN (for PEG-TJ37 only)

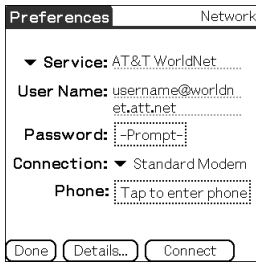

- 8 Tap [▼ Service:], and select [Wireless LAN] from the drop-down list.
- 9 Tap [Done].

Tip

You do not have to enter a Telephone No. into [#####].

Performing the HotSync® operation via a network

You can perform the HotSync® operation via a network when you have prepared your computer settings, CLIÉ handheld settings, and Conduit Setup.

- 1 Rotate the Jog Dial™ navigator to select  (HotSync) on the CLIE Launcher and press the Jog Dial™ navigator. The **HotSync** screen is displayed.

Tip

You can also tap  (HotSync) to display the **HotSync** screen.

- 2 Tap  (HotSync).
The HotSync® operation starts.
A message will be displayed when the HotSync® operation is complete.

Performing the IR HotSync® operation

You can use the IR (infrared) port of your CLIÉ handheld to perform the IR HotSync® operation with a computer equipped with an IrDA (Infrared Data Association) IR port.

Prior to performing the IR HotSync® operation

Check the following items:

- Your computer is equipped with an infrared port supporting the IrDA standard.
- The infrared port of your computer is enabled for use with your Windows operating system.
- Check the port number allocated to the infrared port.
- The infrared port number is available in [Infrared Monitor] in [Control Panel].

For details on the Infrared Monitor, refer to the manual of your computer or the Windows online help.

Preparing your computer

To perform the IR HotSync® operation, you need to allocate a virtual port to the IR HotSync® operation.

For Windows 2000 Professional/Windows XP

- 1 Click  (HotSync) in the Windows task tray (Notification area) at the bottom right of the computer window, and select [IR] from the shortcut menu.
The IR HotSync® operation is enabled.

For Windows Me

- 1 Click  (HotSync) in the Windows task tray (Notification area) at the bottom right of the computer window and select [Local Serial] from the shortcut menu.

Continued on next page

- Click  (HotSync) in the Windows task tray (Notification area) at the bottom right of the computer window once again, and select [Setup...] from the shortcut menu. The **Setup** window is displayed.

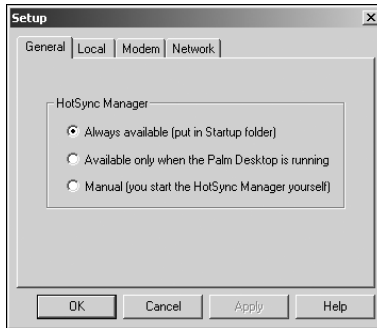

- Click [Local].
- Adjust the following settings as needed.
 - **Serial port:** Specifies a virtual port for an infrared port. If you are not sure of the connection port, refer to [Infrared Monitor] in [Control Panel].
 - **Speed:** Determines the speed at which files/data are transferred. Try the rate, as [As Fast As Possible] first, and adjust downward if you have any problems.
- Tap [OK].
The IR HotSync® operation is enabled.

Note

When performing the local HotSync® operation with a USB cable, you need to restore the local HotSync settings.

➔ For details, refer to “To restore the local HotSync settings” on page 120.

Performing the IR HotSync® operation

You can perform the IR HotSync® operation when you have prepared your computer settings, CLIÉ handheld settings, and Conduit Setup.

- 1 Rotate the Jog Dial™ navigator to select  (HotSync) on the CLIÉ Launcher and press the Jog Dial™ navigator. The **HotSync** screen is displayed.

Tip

You can also tap  (HotSync) to display the **HotSync** screen.

- 2 Tap [Local].
- 3 Tap ▼, and select [IR to a PC/Handheld].
- 4 Point the IR port of your CLIÉ handheld directly to the IR port of the computer.
For best results, your computer and your CLIÉ handheld should be 4 to 8 inches (approximately 10 to 20 centimeters) apart, and the path between your CLIÉ handheld and the computer must be clear of obstacles.
- 5 Tap  (HotSync).
The HotSync® operation starts.
A message will be displayed when the HotSync® operation is complete.

To restore the local HotSync settings

When performing the local HotSync® operation, restore the local HotSync settings with a USB cable.

- 1 Connect your CLIÉ handheld to your computer with a USB cable.
- 2 Click  (HotSync) in the Windows task tray (Notification area) at the bottom right of the computer window, and select [Local USB] from the shortcut menu.

Continued on next page

Performing the HotSync® operation via a modem

You can perform the HotSync® operation via a modem when you are away from your computer.

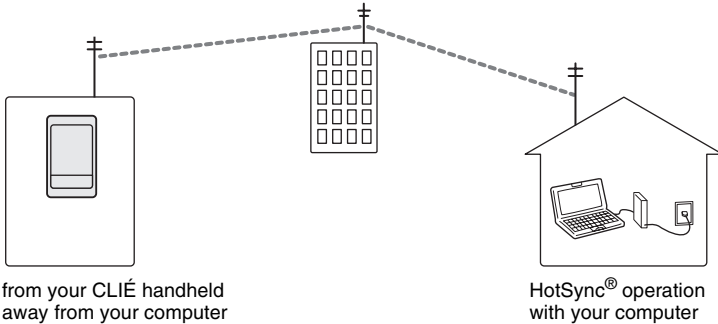

Notes

- For the first HotSync® operation, you need to perform the local HotSync® operation using a USB cable (page 71).
- It may take some time to complete the HotSync® operation via a modem. To shorten the time, define the files/data you wish to synchronize with the modem HotSync® operation in advance. For details, refer to “Selecting the conduits for a modem HotSync® operation” on page 125.

Prior to performing the HotSync® operation via a modem



Check the following items:

- A modem or terminal adaptor (TA) is connected to your computer.
- **Palm™ Desktop for CLIÉ** is properly configured for use with the modem.
 - ➔ For details, refer to “Customizing HotSync® Manager startup and HotSync® setup options” on page 114.

Continued on next page

Preparing your computer

To perform the HotSync® operation via a modem, you need to follow the steps below to set your computer to receive a call from your CLIÉ handheld.

- 1 Check the following items.
 - The modem is connected to your computer and both the modem and computer are turned on.
 - No communication applications, such as fax or telephone software, are running on the COM port.
 - The computer is disconnected from the Internet.
- 2 Click  (HotSync) in the Windows task tray (Notification area) at the bottom right of the computer window and select [Modem] from the shortcut menu.
- 3 Click  (HotSync) in the Windows task tray (Notification area) at the bottom right of the computer window once again and select [Setup...] from the shortcut menu.
The **Setup** window is displayed.
- 4 Click [Modem].

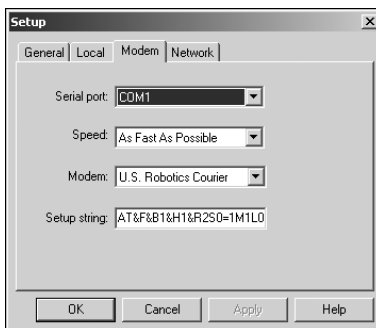

Continued on next page

- Adjust the following settings as needed.
 - Serial port:** Specifies the port for the modem. If you are not sure of the port settings, check [Modem Properties] ([Phone and Modem Options] for Windows 2000 Professional/XP) from [Control Panel].
 - Speed:** Determines the speed at which files/data are transferred. Try the rate, [As Fast As Possible] first, and adjust downward if you have any problems.
 - Modem:** Specifies the modem type or manufacturer. If you are not sure of your modem type or if you cannot find your modem type in the list, select [Hayes Basic].
 - Setup string:** Identifies the setup string for your modem automatically if you specify the modem type or manufacturer. If it does not work properly, refer to the manual of your modem.
- Click [OK].

Preparing your CLIÉ handheld

Follow the steps below to set up your CLIÉ handheld for the modem HotSync® operation.

- Rotate the Jog Dial™ navigator to select  (HotSync) on the CLIE Launcher and press the Jog Dial™ navigator. The **HotSync** screen is displayed.

Tip

You can also tap  (HotSync) to display the **HotSync** screen.

- Tap [Modem].

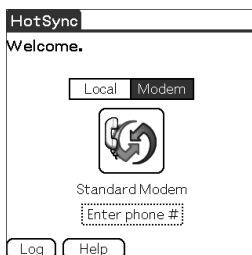

Performing the HotSync® operation via a modem

- 3 Tap [Enter phone #] beneath the modem name.
The **Phone Setup** screen is displayed.

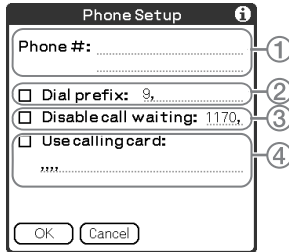

- 4 Adjust the following settings as needed:
 - 1 Enter the telephone number used to access the modem connected to your computer.
 - 2 Enter a dial prefix (such as “9”) to access an outside line, and tap the check box next to [Dial prefix:] as needed. You can also enter a comma in the field to introduce a pause in the dialling sequence. Each comma equals a two second pause.
 - 3 If the phone line you are using for your CLIÉ handheld has Call Waiting, select the check box next to [Disable call waiting:] to avoid an interruption during the modem HotSync® operation.
 - 4 If you want to use a calling card to place the call, select the check box next to [Use calling card:] and enter the calling card number.
- 5 Tap [OK].
The **HotSync** screen is displayed again.

Continued on next page

Selecting the conduits for a modem HotSync® operation

You can specify files/data to be synchronized to shorten the time required to synchronize files/data with a modem.

- ➔ For details, refer to “Customizing HotSync® application settings (Conduit)” on page 111.

Note

If your CLIE handheld settings do not match those made in the **Change HotSync Action** window, the operation complies with the CLIE handheld’s configurations.

- 1 Rotate the Jog Dial™ navigator to select  (HotSync) on the CLIE Launcher and press the Jog Dial™ navigator. The **HotSync** screen is displayed.

Tip

You can also tap  (HotSync) to display the **HotSync** screen.

- 2 Tap  (Menu).
The menu is displayed.
- 3 Tap [Conduit Setup...] from [Options].
The **Conduit Setup** screen is displayed.

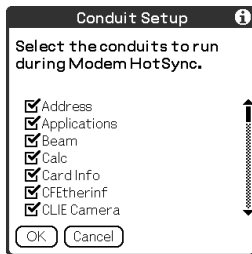

Continued on next page

Performing the HotSync® operation via a modem

- 4 Tap the check boxes to deselect the files/data that you do not want to synchronize during the modem HotSync® operation.

By the default setting, all files/data are selected to be synchronized. The data of applications that do not have a database (such as games) cannot be synchronized.

- 5 Tap [OK].

Performing the HotSync® operation via a modem

You can perform the modem HotSync® operation when you have prepared your computer settings, CLIE handheld settings, and Conduit Setup.

- 1 Rotate the Jog Dial™ navigator to select  (HotSync) on the CLIE Launcher and press the Jog Dial™ navigator. The **HotSync** screen is displayed.

Tip

You can also tap  (HotSync) to display the **HotSync** screen.

- 2 Tap  (HotSync). The HotSync® operation starts. A message will be displayed when the HotSync® operation is complete.

Performing the HotSync[®] operation via a network

To operate HotSync[®] operations via a network, you must have network administrator skills.



You can perform the HotSync[®] operation via a network between your CLIE handheld and the computer in the LAN of your office, depending on the network environment of your office. For details, contact the administrator of the remote access server.

Prior to performing the HotSync[®] operation via a network

Check the following items:

- Both your company's network system and its remote access server support TCP/IP.
- You have a remote access account.

Preparing your computer

- 1** Click  in the Windows task tray (Notification area) at the bottom right of the computer window and select [Network] from the shortcut menu.
- 2** Click  in the Windows task tray (Notification area) at the bottom right of the computer window once again and select [Setup...] from the shortcut menu.
The **Setup** window is displayed.
- 3** Click [Network].
- 4** Click the check box next to the user name for the HotSync[®] operation.
Click [TCP/IP Settings...] and assign a subnet mask as needed. For details on a subnet mask address, refer to the manual of your operating system or contact the system administrator.
- 5** Click [OK].

Performing the HotSync® operation via a network

- 6 Connect a USB cable to your CLIÉ handheld and press  (the HotSync button).

The computer information (Primary PC name and Primary PC address (IP address)) is transferred to your CLIÉ handheld.

When you perform the HotSync® operation via a network, your CLIÉ handheld identifies the computer based on the transferred information.

Preparing your CLIÉ handheld

Follow the steps below to set up your CLIÉ handheld for the HotSync® operation via a network.

- 1 Rotate the Jog Dial™ navigator to select  (HotSync) on the CLIE Launcher and press the Jog Dial™ navigator. The **HotSync** screen is displayed.

Tip

You can also tap  (HotSync) to display the **HotSync** screen.

- 2 Tap [Modem].
- 3 Tap  (Menu).
The menu is displayed.
- 4 Tap [Modem Sync Prefs...] from [Options].
The **Modem Sync Preferences** screen is displayed.

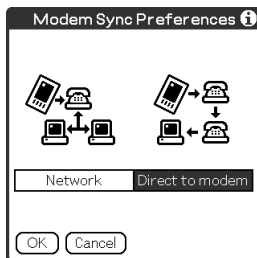

- 5 Tap [Network].
- 6 Tap [OK].
The **HotSync** screen is displayed.
- 7 Tap [Select Service] beneath the icon.
The **Preferences** screen for [Network] is displayed.

Preferences Network

▼ Service: AT&T WorldNet

User Name: username@worldnet.att.net

Password: -Prompt-

Connection: ▼ Standard Modem

Phone: Tap to enter phone:

Done Details... Connect

- 8 Tap [▼ Service:] and select [Unix] or [Windows RAS] from the drop-down list.
► For details, refer to “Setting the Network preferences for your provider and dial-up server” on page 88 and contact the administrator of the remote access server.
- 9 Tap [Done].
- 10 Tap [Enter phone #].
The **Phone Setup** screen is displayed.
- 11 Adjust the settings on the screen as needed.
- 12 Tap [OK].
The **HotSync** screen is displayed.
- 13 Follow “Performing the HotSync® operation via a modem” on page 121 to select files/data to be synchronized.

Performing the HotSync® operation via a network

You can perform the HotSync® operation via a network when you have prepared your computer settings, CLIE handheld settings, and Conduit Setup.

- 1 Rotate the Jog Dial™ navigator to select  (HotSync) on the CLIE Launcher and press the Jog Dial™ navigator. The **HotSync** screen is displayed.

Tip

You can also tap  (HotSync) to display the **HotSync** screen.

- 2 Tap  (HotSync). The HotSync® operation starts. A message will be displayed when the HotSync® operation is complete.

Performing the HotSync® operation via LAN (LANSync)

To operate LANSync, you must have network manager skills. Consult a network manager prior to setting LANSync.

You can perform the HotSync® operation via LAN between your computer and another computer connected to your CLIÉ handheld.

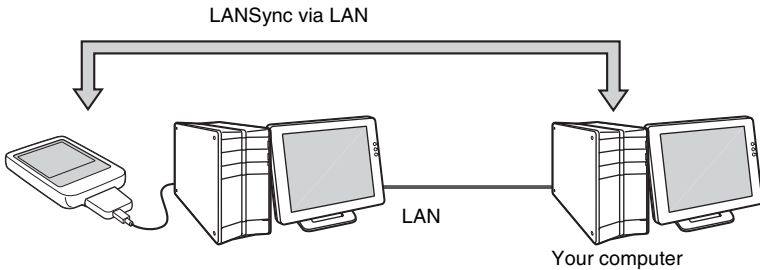



Prior to performing a LANSync operation



Check the following items:

- **Palm™ Desktop for CLIÉ** is installed in both computers connected by the LAN.
- Your CLIÉ handheld is connected to the USB cable with plug adapter correctly and the another side of the USB cable is connected to the computer properly.

Preparing your computer

- 1 Click  (HotSync) in the Windows task tray (Notification area) at the bottom right of the computer window, and select [Network] from the shortcut menu.
- 2 Click  (HotSync) in the Windows task tray (Notification area) at the bottom right of the computer window once again, and select [Setup...] from the shortcut menu.
The **Setup** window is displayed.
- 3 Click [Network].
- 4 Click the check box next to the user name for the HotSync® operation.
- 5 Click [OK].

Performing the HotSync® operation via LAN (LANSync)

- 6 Connect your CLIÉ handheld to your computer with a USB cable.
- 7 Rotate the Jog Dial™ navigator to select  (HotSync) on the CLIE Launcher and press the Jog Dial™ navigator.
- 8 Tap  (HotSync).

The computer information (Primary PC name and Primary PC address (IP address)) is transferred to your CLIÉ handheld.
When you perform the HotSync® operation via LAN, your CLIÉ handheld identifies the computer based on the transferred information.

Preparing your CLIÉ handheld

Follow the steps below to set up your CLIÉ handheld for the HotSync® operation via the LAN.

- 1 Rotate the Jog Dial™ navigator to select  (HotSync) on the CLIE Launcher and press the Jog Dial™ navigator.
The **HotSync** screen is displayed.

Tip

You can also tap  (HotSync) to display the **HotSync** screen.

- 2 Tap [Local].
- 3 Tap  (Menu).
The menu is displayed.
- 4 Tap [LANSync Prefs...] from [Options].
The **LANSync Preferences** screen is displayed.

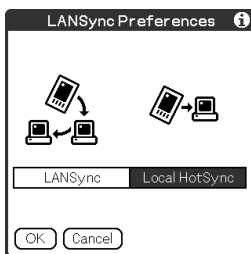

- 5 Tap [LANSync].

- 6 Tap [OK].
The **HotSync** screen is displayed again.

Performing the LANSync operation

You can perform the LANSync operation when you have prepared your computer settings, CLIÉ handheld settings, and Conduit Setup. Turn on the computers and start **HotSync® Manager**.

Note

To perform the LANSync operation, both the computer connected to your CLIÉ handheld and the computer performing the HotSync® operation should be set for LANSync. Also, click  (HotSync) to display the shortcut menu in the Windows task tray (Notification area) at the bottom right of the computer window on each computer and make sure that [Network] in the shortcut menu is selected (If not, click [Network] to select it).

- 1 Rotate the Jog Dial™ navigator to select  (HotSync) on the CLIÉ Launcher, and press the Jog Dial™ navigator.
The **HotSync** screen is displayed.

Tip

You can also tap  (HotSync) to display the **HotSync** screen.

- 2 Tap  (HotSync).
The HotSync® operation starts.
A message will be displayed when the HotSync® operation is complete.



Using “Memory Stick™” media

This chapter explains how to communicate with another Palm OS® PDA device via “Memory Stick” media, how to handle “Memory Stick” media, and how to use **CLIE Files** for managing the files/data on “Memory Stick” media.

Using “Memory Stick™” media	135
Exchanging data via “Memory Stick” media	145

Using “Memory Stick™” media

..... The type of storage media you can use with your CLIÉ handheld

You can use your CLIÉ handheld with “Memory Stick” media as the storage media. “Memory Stick” media is specially designed for exchanging and sharing files/data among “Memory Stick” media compatible products. Because it is removable, “Memory Stick” media can also be used for external files/data storage.

“Memory Stick” media enable you to exchange files/data between your CLIÉ handheld and a computer. To exchange files/data via “Memory Stick” media, you can use **CLIE Files**, supplied with your CLIÉ handheld.

..... Using “Memory Stick” media

There are two types of “Memory Stick” media:

- “MagicGate Memory Stick” media, which is equipped with “MagicGate”* copyright protection technology.
- “Memory Stick” media, which is not equipped with “MagicGate” copyright protection technology.

*What is MagicGate?

MagicGate is the copyright protection technology that is used for “MagicGate Memory Stick” media and MagicGate compatible devices, such as a CLIÉ handheld. MagicGate certifies the compatible device and “MagicGate Memory Stick” media as copyright protection-compatible devices and encodes files/data to be played back on devices. Copyrighted files/data cannot be played back on non-certified devices.

“Memory Stick Duo”, “MagicGate Memory Stick Duo”, “Memory Stick PRO”**, and “Memory Stick PRO Duo”*** can be used with your CLIÉ handheld.

However, you cannot store/play-back the files/data which is equipped with “MagicGate” copyright protection technology.

** You can use the “Memory Stick PRO” MSX-1G, MSX-512, and MSX-256 with your CLIÉ handheld.

*** You can use the “Memory Stick PRO Duo” MSX-M512A, and MSX-M256A with your CLIÉ handheld.

However, you cannot record or play back files/data that have been copyright protected with the MagicGate function.

➔ For the latest information, refer to the URL shown on the last page of this manual.

Continued on next page
.....

Note on using “MagicGate Memory Stick” media

Do not handle copyright-protected files/data or directories stored on “MagicGate Memory Stick” media with **CLIE Files** or Windows® Explorer, otherwise the files/data may be disabled. To handle copyright-protected files/data, use a “MagicGate” compliant application.

Notes

When using a “Memory Stick Duo” media with your CLIE handheld

- Make sure you use a “Memory Stick Duo” adaptor.
- Make sure you insert a “Memory Stick Duo” media into the “Memory Stick Duo” adaptor in the right direction.
- Make sure you insert a “Memory Stick Duo” media into the adaptor before you insert the adaptor into the “Memory Stick” slot of your CLIE handheld.
- Make sure you insert a “Memory Stick Duo” adaptor into the “Memory Stick” slot of your CLIE handheld in the right direction.

Notes on using “Memory Stick” media

When you use “Memory Stick” media, follow the precautions below.

- Avoid touching the terminals of “Memory Stick” media with your fingers or a metal object.
- Do not drop, bend, or expose “Memory Stick” media to external shock.
- Do not disassemble or modify “Memory Stick” media.
- Avoid getting liquid on “Memory Stick” media.
- Avoid using or storing “Memory Stick” media in a location subject to:
 - extremely high temperature such as inside a hot car, outdoors in direct sunlight, or near a heater
 - direct sunlight
 - high humidity
 - corrosive substances
 - excessive dust
 - magnetic fields
- When storing and carrying “Memory Stick” media, keep it in its original case to ensure protection of important files/data.
- Make a backup of important files/data.
- Avoid removing “Memory Stick” media from the insertion slot while files/data is being written or read.
- To avoid damaging or erasing files/data, do not
 - pull out “Memory Stick” media or unplug the AC power adapter while formatting, or reading or writing files/data.
 - use “Memory Stick” media in a location subject to static electricity or electrical interference.

Continued on next page

- If the battery power of your CLIÉ handheld is running low, an error message is displayed and you cannot exchange files/data with “Memory Stick” media. If this occurs, connect the AC power adapter with plug adapter to your CLIÉ handheld or fully charge your CLIÉ handheld.
- Use **CLIE Files** to format the “Memory Stick” media you use in your CLIÉ handheld. If you format it using another application, further operation with your CLIÉ handheld is not guaranteed.
- If you insert “Memory Stick” media that has been formatted by another application, a message prompting you to reformat it is displayed. To use “Memory Stick” media in your CLIÉ handheld, follow the instructions to format it. Note, however, that all stored files/data will be erased.
- Make sure you use a suitable label on the “Memory Stick” media.

Protecting the files/data on “Memory Stick” media

To prevent accidental erasure of important files/data, you can use the write protect tab on the “Memory Stick” media.

Write enable position

Slide the tab to the left to select the write enable position. You can read and write files/data on the “Memory Stick” media.

Write protect position (LOCK)

Slide the tab to the right to select the write protect position. You can only read the files/data on the “Memory Stick” media. Select the write protect position when you insert “Memory Stick” media containing any important files/data that you do not want to accidentally delete or overwrite.

Back side

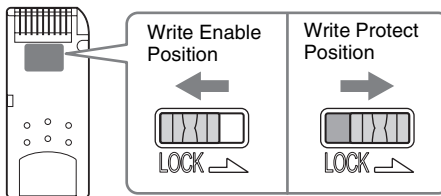

Tip

Shape or exact location of the tab may differ from the illustration.

Starting an application on “Memory Stick” media

You can start applications on “Memory Stick” media in the same way as applications on your CLIE handheld. While the power of your CLIE handheld is on, the applications in the “Memory Stick” media will be displayed on the CLIE Launcher automatically when you insert the “Memory Stick” media into the slot. (The feature does not work when certain applications are running).

To switch from the CLIE Launcher to the screen where the applications in “Memory Stick” media are displayed, perform the following steps.

Note

Starting application supplied with your CLIE handheld from “Memory Stick” media is not supported.



Tip

You can only start the applications stored in the [/Palm/Launcher] directory.

- 1 Insert the “Memory Stick” media into your CLIE handheld.
- 2 Move the selection area to the CLIE Launcher groups list by pressing  (the Left button) on the CLIE Launcher.



Continued on next page

- 3** Select  (Card) by rotating the Jog Dial™ navigator, or by tap  (Card).

The applications stored in the [/Palm/Launcher] directory on “Memory Stick” media are displayed.

You can start an application in the same way that you start an application of your CLIE handheld.

If you have assigned a name to “Memory Stick” media, then the  (Card Name) is displayed in that name.

Note

Depending on the application, some of the features may not work if you start the application on “Memory Stick” media. In this case, use **CLIE Files** to copy the files/data on your CLIE handheld and use the copied files/data.

Viewing information of “Memory Stick” media (Card Info)

You can view information (e.g., remaining memory space) of “Memory Stick” media with **Card Info**.

- 1 Insert the “Memory Stick” media into your CLIE handheld.
- 2 Rotate the Jog Dial™ navigator to select  (Card Info) on the CLIE Launcher and press the Jog Dial™ navigator. The **Card Info** screen is displayed.

Tip



You can also tap  (Card Info) to display the **Card Info** screen.

- 3 Tap ▼ next to [Card:] to select “Memory Stick” media. The information screen of “Memory Stick” media is displayed.

Card Info
Card: ▼  Card
Type: Memory Stick
Size: 17.2 MB Free of 61.8 MB
44.5 MB Used 17.2 MB Free of 61.8 MB
MEMORYSTICK (64M)
SONY
Memory Stick
Device Id:

.....
Assigning a name to “Memory Stick” media

You can assign a name to “Memory Stick” media with **Card Info**.

- 1** Insert the “Memory Stick” media into your CLIÉ handheld.
- 2** Rotate the Jog Dial™ navigator to select  (Card Info) on the CLIE Launcher and press the Jog Dial™ navigator. The **Card Info** screen is displayed.
- 3** Tap  (Menu). The menu is displayed.
- 4** Tap [Rename Card] from [Card]. The **Rename Card** dialog box is displayed.

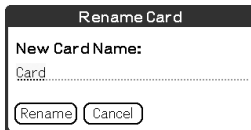

- 5** Enter a new name for the inserted “Memory Stick” media and tap [Rename].

.....
Formatting “Memory Stick” media

If you format your “Memory Stick” media, use always **CLIE Files** or **Card Info**. The following explains how to format “Memory Stick” media with **CLIE Files**. (Purchased “Memory Stick” media is already formatted for use.)

- 1** Insert the “Memory Stick” media into your CLIE handheld.
- 2** Rotate the Jog Dial™ navigator to select  (CLIE Files) on the CLIE Launcher and press the Jog Dial™ navigator. **CLIE Files** starts.

Tip

You can also tap  (CLIE Files) to start **CLIE Files**.

- 3** Tap  at the top right of the **CLIE Files** screen to select [MS].

Tip

You can also tap  (MS) to select.

- 4** Tap  (Menu).
The menu is displayed.
- 5** Tap [Format] from [Tool].
The **Enter name** dialog box is displayed.
- 6** Enter a new name for the “Memory Stick” media and tap [OK].
A confirmation message is displayed.

- 7** Tap [OK].

To cancel formatting

Tap [Cancel] in Step 6, 7.

Continued on next page
.....

What is formatting?

Formatting defines the recording format for your “Memory Stick” media so that you can access files/data with your CLIÉ handheld.

Notes

- If “Memory Stick” media is reformatted, all the files/data stored on the “Memory Stick” media will be erased. Make sure you check the files/data prior to formatting so that you do not delete important files/data.
- When formatting “Memory Stick” media for use with your CLIÉ handheld, be sure to format it on your CLIÉ handheld. “Memory Stick” media formatted by any other device may not be read or written properly on your CLIÉ handheld.
- If you remove the “Memory Stick” media during formatting, the “Memory Stick” media will not be usable. In this case, insert “Memory Stick” media again and restart formatting.

Exchanging data via “Memory Stick” media

Starting CLIE Files

You can copy, move, or delete files/data between “Memory Stick” media and your CLIE handheld with **CLIE Files**.

➔ For details on **CLIE Files**, refer to “CLIE Files” in the “CLIE Application Manual” installed on your computer.



- 1 Insert the “Memory Stick” media into your CLIE handheld.
- 2 Rotate the Jog Dial™ navigator to select  (CLIE Files) on the CLIE Launcher and press the Jog Dial™ navigator. **CLIE Files** starts.

Tip

You can also tap  (CLIE Files) to start **CLIE Files**.

- 3 Tap ▼ at the top right of the **CLIE Files** screen to select [Handheld] or [MS].

Tip

You can also tap  (Handheld), or  (MS) to select.

Continued on next page

When displaying the files/data on “Memory Stick” media

Tap here to sort in ascending or descending order

Tap here to switch the view
Handheld: CLIÉ handheld
MS: “Memory Stick” media

Tap here to switch to the Directory list screen

Tap here to switch the view of the following:

- size: File size
- date: Updated date
- time: Updated time
- creator: Creator ID of the file
- type: File type
- version: Version of the file
- none: no items displayed

Tap here to switch the view between your CLIÉ handheld and “Memory Stick” media

Tap here to switch the view of the following:

- Name: name displayed on the computer
- DBname: name assigned on your CLIÉ handheld

: Tap to display the contents of the zip files*

: Tap to display the contents of the directory*

: Tap to display the upper directory*

* , and are specific to the screen when displaying the data on “Memory Stick” media. Except for these icons, all icons in the screen are common to the one when displaying the files/data on your CLIÉ handheld. You can also rotate the Jog Dial™ navigator to select a directory.

Tip

You can select a directory in the **Directory list** screen and tap [OK] to display the contents of the directory. Additionally, you can tap [New] to create a new directory or tap [Rename] to change the name of existing directory.

Notes

- You can display up to nine levels of the directory tree.
- The latest change date of the database may not be displayed correctly, depending on how the application was installed.
- When the battery power of your CLIÉ handheld is insufficient, files/data on “Memory Stick” media will not be displayed. In this case, you need to charge your CLIÉ handheld or connect the AC power adapter with plug adapter to your CLIÉ handheld.

Continued on next page

When displaying the data on your CLIÉ handheld

Tap here to switch the database display by group

- All data bases
- Creator group
- Application

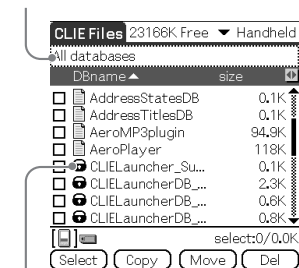

 (Lock icon)

Notes on moving or deleting files/data using CLIE Files

In some cases when you move or delete specific files/data using **CLIE Files**, some CLIÉ handheld applications may not operate properly or some files/data may be formatted. Sony is not liable for any problems with applications or files/data, that arise from your moving or deleting a file/data.

Do not move or delete the following files:

- **Saved Preferences:** The final operation status or settings for various applications.
- **Unsaved Preferences:** The settings for various applications or user information of your CLIÉ handheld. If this file is deleted, you may not be able to synchronize the correct information.
- **CLIELauncherXXX:** The database for the CLIE Launcher. If this file is deleted, you may not be able to operate the CLIE Launcher.
- **NetworkDB:** Network settings. If this file is deleted, network connection is disabled.
- **AddressDB:** The database for **Address Book***.
- **DatebookDB:** The database for **Date Book***.
- **MemoDB:** The database for **Memo Pad***.
- **ToDoDB:** The database for **To Do List***.

* These database files can be copied to “Memory Stick” media as a backup file. If you copy them back to your CLIÉ handheld, the identical files on your CLIÉ handheld will be overwritten with the information at the time of the backup. Note that any added or edited information in your CLIÉ handheld after the backup will not be restored.

Continued on next page

Note

When the battery power of your CLIÉ handheld is insufficient, data on “Memory Stick” media will not be displayed. In this case, you need to charge your CLIÉ handheld or connect the AC power adapter with plug adapter to your CLIÉ handheld.

Copying your CLIÉ handheld data to “Memory Stick” media

You can save your CLIÉ handheld data to “Memory Stick” media with **CLIE Files**.

Notes

- Since copying data consumes a lot of power, you cannot use “Memory Stick” media when your CLIÉ handheld battery power is low. In this case, connect the AC power adapter with plug adapter to your CLIÉ handheld.
- If your CLIÉ handheld receives IR communication while copying data, the copying will be interrupted. Do not allow your CLIÉ handheld to receive IR communication while copying data.
- Insert “Memory Stick” media into your CLIÉ handheld before copying or moving data. Never remove “Memory Stick” media while you are copying or moving data between your CLIÉ handheld and “Memory Stick” media.
- Incomplete copying or moving may leave an invalid file on your CLIÉ handheld or the “Memory Stick” media. In this case, retry copying or moving, and if the confirm overwrite message is displayed, tap [Yes] or [Yes to all].

- 1** Insert the “Memory Stick” media into your CLIÉ handheld.
- 2** Rotate the Jog Dial™ navigator to select  (CLIE Files) on the CLIE Launcher and press the Jog Dial™ navigator. **CLIE Files** starts.

Tip

You can also tap  (CLIE Files) to start **CLIE Files**.

Continued on next page

- 3 Tap **▼** at the top right of the **CLIE Files** screen to select [Handheld].

All the CLIE handheld data are displayed.

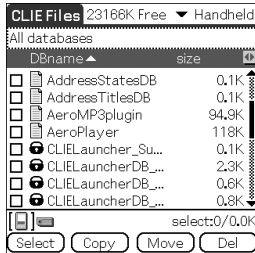

Tip

You can also tap  (Handheld) to select.

- 4 Tap the data you want to copy to change to .

You can select multiple items by selecting the check boxes.

Note

Data marked with  cannot be copied.

- 5 Tap [Copy].

The **Directory list** screen is displayed.

- 6 Tap the “Memory Stick” media directory.

When you want to create a new directory on “Memory Stick” media, tap [New] and enter the directory name. Tap the created directory.

When you want to rename an existing directory, tap [Rename] and enter the new name.

- 7 Tap [OK].

The data are copied to the directory selected in Step 6.

To copy all the data at once

Tap [Select] in Step 4 and select [Select All].

To cancel the selection

- **To cancel all the selections:** tap [Select] and select [Clear All].
- **To clear only specific items:** tap the selected item once again.

When you want to select data other than the specified one

After following Step 4, tap [Select] and select [Invert]. The selections of and are reversed.

Moving your CLIÉ handheld data to “Memory Stick” media

When the available memory in your CLIÉ handheld is insufficient, you can move the data from your CLIÉ handheld to “Memory Stick” media.

- 1** In Step 5 of “Copying your CLIÉ handheld data to “Memory Stick” media”, tap [Move].
The selected data on your CLIÉ handheld are transferred to “Memory Stick” media and saved.

Copying data on “Memory Stick” media to your CLIE handheld

You can copy the data saved on “Memory Stick” media to your CLIE handheld. Prior to copying data, make sure that the memory space of your CLIE handheld is sufficient.

Tip

You can also copy data to another directory on “Memory Stick” media.

- 1 Insert the “Memory Stick” media into your CLIE handheld.
- 2 Rotate the Jog Dial™ navigator to select  (CLIE Files) on the CLIE Launcher and press the Jog Dial™ navigator. **CLIE Files** starts.

Tip

You can also tap  (CLIE Files) to start **CLIE Files**.

- 3 Tap  at the top right of the **CLIE Files** screen to select [MS]. All the files/directories on “Memory Stick” media are displayed.

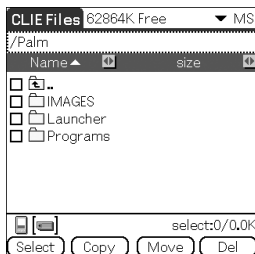

Tip

You can also tap  (MS) to select.

- 4 Tap the data you want to copy to change to . You can select multiple items by selecting the check boxes.
- 5 Tap [Copy]. The **Directory list** screen is displayed.

Continued on next page

6 Select [Handheld].

7 Tap [OK].

The data selected in Step 4 are copied to [Handheld].



To copy all the data at once

Tap [Select] in Step 4 and select [Select All].

To cancel the selection

- **To cancel all the selections:** tap [Select] and select [Clear All].
- **To clear only specific items:** tap the selected item once again.

To change the directory to be copied

Tap  or  to select the directory you want to copy. The displays of the directory are changed. You can specify a directory to be copied.

Moving data on “Memory Stick” media to your CLIÉ handheld

You can move the data from “Memory Stick” media to your CLIÉ handheld.

1 In Step 5 of “Copying data on “Memory Stick” media to your CLIÉ handheld”, tap [Move].

The selected data on “Memory Stick” media are transferred to your CLIÉ handheld and saved.

Note

Some data copied from “Memory Stick” media to your CLIÉ handheld may not be synchronized during the HotSync® operation.

Deleting files/directories on “Memory Stick” media

You can delete the files/directories from “Memory Stick” media with **CLIE Files**.

- 1 Insert the “Memory Stick” media into your CLIE handheld.
- 2 Rotate the Jog Dial™ navigator to select  (CLIE Files) on the CLIE Launcher and press the Jog Dial™ navigator. **CLIE Files** starts.

Tip

You can also tap  (CLIE Files) to start **CLIE Files**.

- 3 Tap  at the top right of the **CLIE Files** screen to select [MS]. All the files/directories on “Memory Stick” media are displayed.

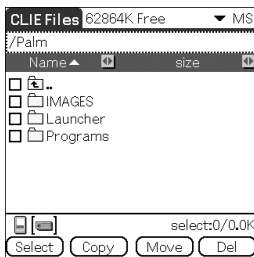

Tip

You can also tap  (MS) to select.

- 4 Tap the file/directories you want to delete to change to .
- 5 Tap [Del].
The **Delete File** dialog box is displayed.
- 6 Tap [OK].
The files/directory selected in Step 4 are deleted from “Memory Stick” media.

Continued on next page



To delete all the data at once

Tap [Select] in Step 4 and select [Select All].

To cancel the selection

- **To cancel all the selections:** tap [Select] and select [Clear All].
- **To clear only specific items:** tap the selected item once again.

To change the directory to be deleted

Tap  or  to select the directory you want to delete. The displays of the directory are changed. You can specify a directory to be deleted.

Continued on next page

Extracting a Zip file

You can extract Zip files without using a computer.

Note

Password protected ZIP files are not supported.

- 1 Insert the “Memory Stick” media stores the Zip file into your CLIE handheld.
- 2 Rotate the Jog Dial™ navigator to select  (CLIE Files) on the CLIE Launcher and press the Jog Dial™ navigator. **CLIE Files** starts.

Tip

You can also tap  (CLIE Files) to start **CLIE Files**.

- 3 Tap ▼ at the top right of the **CLIE Files** screen to select [MS]. All the files/directories on “Memory Stick” media are displayed.  is a Zip file.



Continued on next page

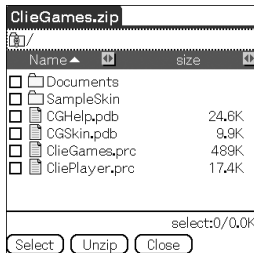

- 4 Tap the Zip file you want to extract.
The contents of the Zip file are displayed on the screen.



- 5 Tap the file you want to extract to change to .
You can select multiple files by selecting the check boxes.
- 6 Tap [Unzip].
The **Directory list** screen is displayed.
- 7 Tap a directory in which to save the extracted data.
You can also save the data on your CLIÉ handheld.

Note

Some data cannot be saved on your CLIÉ handheld. In these cases, an error message is displayed.

- 8 Tap [OK].
The data is extracted to the directory selected in Step 7.
 - : Files that were extracted normally.
 - : Files that could not be extracted.
 - : Files that were skipped during extraction.
- 9 Tap [Close].



To extract all the data at once

Tap [Select] in Step 5 and select [Select All].

To cancel the selection

- To cancel all the selections: tap [Select] and select [Clear All].
- To clear only specific items: tap the selected item once again.

To change the directory to be deleted

Tap  or  to select the directory you want to delete. The displays of the directory are changed. You can specify a directory to be deleted.

..... **CLIE Files menu items**

The following describes the menu items that are specific to **CLIE Files**.

For the menu items common to CLIE handheld applications, refer to “Common menu items” on page 43.

Menus from [Tool]





[Format]	Formats (initializes) “Memory Stick” media inserted into your CLIE handheld. Note that all data stored on “Memory Stick” media will be erased when formatting the “Memory Stick” media.
[Media Info]	Displays information, such as the amount of memory or volume label, of your CLIE handheld or “Memory Stick” media.
[New Dir]	Creates a directory within the current directory on “Memory Stick” media. (Only when “Memory Stick” media is selected).
[Rename]	Changes the name of current directory or file. (Only when “Memory Stick” media is selected).
[About CLIE Files]	Displays the version information of CLIE Files .

..... Exchanging files/data without using CLIE Files

You can exchange the data between “Memory Stick” media and your CLIE handheld from the menu of the CLIE Launcher.

However, problems may occur depending on the application. Note the following.

- You can copy only applications to “Memory Stick” media. Related data cannot be copied.
- Data stored on “Memory Stick” media (e.g., image files) cannot be displayed.
- Data marked with  cannot be copied.

- 1** Insert the “Memory Stick” media into your CLIE handheld.
- 2** Tap  (Menu) while the CLIE Launcher is displayed.
The menu is displayed.
- 3** Tap [Copy...] from [CLIE Launcher].
The **Copy** window is displayed.
- 4** Tap ▼ next to [Copy To:], and select [Handheld] or  Card].
- 5** Tap ▼ next to [From:] to select  Card] or [Handheld].
- 6** Tap the application you want to copy.
- 7** Tap [Copy].
The selected application is copied to [Handheld] or  Card].

Notes on starting applications from “Memory Stick” media

When an application is installed on “Memory Stick” media by the HotSync® operation, be careful of the following.

- Related files/data such as image files or movie files may not be opened (played back).
- When files/data saved on “Memory Stick” media cannot be opened in the application, move the files/data to your CLIE handheld, or delete them by using **CLIE Files**.

Tip

When PRC format (.prc) or PDB format (.pdb) files are installed on “Memory Stick” media with the HotSync® operation, the files are stored in [/Palm/Launcher] directory.



Beaming

This chapter explains how to communicate with another Palm OS[®] PDA device via the infrared communications port.

Beaming between your CLÍÉ handheld and another Palm OS[®] PDA 162

Beaming between your CLIÉ handheld and another Palm OS[®] PDA

What you can do with beaming

Your CLIÉ handheld is equipped with an IR (infrared) port that enables you to exchange data or applications with another Palm OS[®] PDA device that has an IR port. The IR port is located at the top of your CLIÉ handheld, behind the small dark shield.

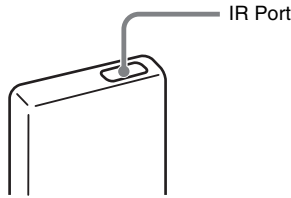

Location of the IR port may vary depending on your model.

You can beam the following information between your CLIÉ handheld and another Palm OS[®] PDA device that has an IR port:

- The data of **Address Book**, **Date Book**, **To Do List**, or **Memo Pad**.
- All data in the category currently displayed in **Address Book**, **To Do List**, or **Memo Pad**.
- Address Book data that you designate as your business card.
- Add-on applications installed in the memory.

Note

Some applications are protected from copying and cannot be beamed. Applications marked with  cannot be copied.

Beaming information

You can beam the data on your CLIÉ handheld to another Palm OS® PDA device that has an IR port.

- 1 Select the data, category, or business card you want to beam.
- 2 Tap  (Menu).
The menu is displayed.
- 3 Tap one of the following:
 - The Beam command for an individual record
 - In Address only: Beam Business Card
 - Beam Category

Tip

You can also perform [Beam Business Card] by pressing the Address Book button for about 2 seconds.

- 4 When the **Beam** dialog box is displayed, point the IR port of your CLIÉ handheld directly to the IR port of another Palm OS® PDA device.
The **Beam** dialog box shows that the transfer is complete.





Location of the IR port may vary depending on your model.

Tip

For best performance of the data exchange, keep 4 to 8 inches (approximately 10 to 20 centimeters) between your CLIÉ handheld and the other Palm OS® PDA device. Do not place any obstacle between the devices. The optimum distance for beaming may vary depending on devices.

Continued on next page

Sending applications via beaming

- 1** Tap  (Menu) while the CLIE Launcher is displayed.
The menu is displayed.
- 2** Tap [Beam...] from [CLIE Launcher].
The **Beam** screen is displayed.
- 3** Tap ▼ next to [Beam From:] and select [Handheld].
Select [Handheld] when the application you want to send is saved on your CLIÉ handheld or  (card) when it is saved on [/Palm/Launcher] directory on “Memory Stick” media.
- 4** Tap an application you want to send, on the **Beam** screen.
Some applications are protected from copying and cannot be beamed.
Applications marked with  cannot be copied.
- 5** Tap [Beam].
A message will be displayed when the beaming is complete.

Continued on next page

Receiving beamed information

- 1** Turn on your CLIÉ handheld and point the IR port of your CLIÉ handheld directly to the IR port of another Palm OS PDA device.
The **Beam** screen is displayed and beaming of data or applications starts.
- 2** Select the category where you want to save the received data or applications.
Data or applications received by beaming are saved in the **Unfiled** category.
You can also create a new category to save the data or applications, or save it in the **Unfiled** category.
- 3** Tap [Yes].
The data or applications are saved.

Note

When [Beam Receive:] in the **Preferences** screen for [General] is set to [Off], you cannot receive data or applications using the beaming feature. Prior to beaming data or applications, set [Beam Receive:] to [On].



Backing up your CLIE™ handheld data and applications

This chapter explains how to make a backup of your CLIE handheld data.

Backing up your CLIE™ handheld data and applications	167
Backing up data and applications to your computer with the HotSync® operation.	167
Backing up data and applications to “Memory Stick” media using Memory Stick Backup.	168

Backing up your CLIÉ™ handheld data and applications

You can create a backup of your CLIÉ handheld data by following two methods:

- Backing up to your computer.
- Backing up to “Memory Stick” media with **Memory Stick Backup**.

Backing up data and applications to your computer with the HotSync® operation

By the default settings, you can back up the following data to your computer through the HotSync® operation:

- Memo Pad files/data
- Address Book files/data
- To Do List files/data
- Date Book files/data
- Preferences files/data
- Application files/data that have been installed using the HotSync® operation
- User information files to perform the HotSync® operation

When the HotSync® operation is performed, the backup data is compared with the data in your computer, and the newer data becomes effective. If you perform a hard reset, all data stored on your CLIÉ handheld is erased and the initial status will be restored. If this happens, you can restore the backup data from your computer that was created through the previous HotSync® operation.

Notes

- The following applications or data cannot be backed up with the HotSync® operation.
 - Applications or data beamed or transferred from a “Memory Stick” media.
 - Certain applications or driver files added later, or certain data in an application.In this case, back up them to “Memory Stick” media with **Memory Stick Backup**. For details on applications that cannot be backed up, refer to the manual of each application.
- If you restore data by the HotSync® operation, perform a HotSync promptly after performing a hard reset. If data is created on your CLIÉ handheld before performing the HotSync® operation, the new data may be lost at the data restoration.
- If you customize settings in the **Change HotSync Action** window, you may not be able to create a back up file. You cannot back up an application or restore its data if an option other than [Synchronize the files] is selected.
 - ➔ For details, refer to “Customizing HotSync® application settings (Conduit)” on page 111.

.....

Backing up data and applications to “Memory Stick” media using Memory Stick Backup

With **Memory Stick Backup**, you can back up the following applications and data to “Memory Stick” media.

- Memo Pad files/data
- Address Book files/data
- To Do List files/data
- Date Book files/data
- Preferences files/data
- Add-on application files/data

1 Insert “Memory Stick” media into your CLIÉ handheld.

2 Tap  (Home).
The CLIÉ Launcher is displayed.

3 Rotate the Jog Dial™ navigator to select  (MS Backup) on the CLIÉ Launcher and press the Jog Dial™ navigator. **Memory Stick Backup** starts.

Tip

You can also tap  (MS Backup) to start **Memory Stick Backup**.

4 Tap  (Backup).
The **Backup All Files** dialog box is displayed.

5 Tap [OK].
The **Backup Progress** screen is displayed.
General information of the backup (date, size, and number of database) is displayed in the list.

Continued on next page

.....

Note

When backing up data to “Memory Stick” media, free space greater than the size of the data to be backed up, is needed on the “Memory Stick” media. The battery power of your CLIÉ handheld and memory space of “Memory Stick” media should be adequate. Otherwise, data may not be backed up or restored properly.

Tips

- The backup takes a few minutes.
- In Step 4, you can also select an existing file from the backup list then tap  (Backup) to overwrite it.
- The data size displayed in the list shows the size of the applications and data stored in CLIÉ handheld.
- **Number of database** shows the number of applications and data that have been backed up.
- If a backup file on “Memory Stick” media has been updated using **CLIE Files**, the file may not be restored properly.

To delete a backup file from the “Memory Stick” media

Select the backup data you want to delete in the Backup list, and tap [Delete].

Restoring backup data and applications to your CLIÉ handheld

Notes

- When you restore backup data and applications to your CLIÉ handheld, the data currently saved on your CLIÉ handheld will be overwritten with the backup data. Any data created or edited after you saved the backup will be lost.
- You can only restore data to the CLIÉ handheld from which you took that backup.

1 Perform a hard reset on your CLIÉ handheld.

- For details on a hard reset, refer to “Basic operations of your CLIÉ™ handheld: Restarting your CLIÉ handheld” in the “Read This First (Operating Instructions).”

2 Insert the “Memory Stick” media containing the backup files into your CLIÉ handheld.

3 Tap (Home). The CLIE Launcher is displayed.

Continued on next page

- 4 Rotate the Jog Dial™ navigator to select  (MS Backup) on the CLIE Launcher and press the Jog Dial™ navigator. **Memory Stick Backup** starts and the backup list appears.

Tip

You can also tap  (MS Backup) to start **Memory Stick Backup**.

- 5 Tap the backup data you want to restore from the list.

- 6 Tap  (Restore).
The **Restore All Files** dialog box is displayed.

- 7 Tap [OK].
The **Confirm Restore** dialog box is displayed.

- 8 Tap [OK].
The **Restore Progress** screen is displayed.
If there was initial data automatically created by each application when you performed a hard reset or if you created or updated data after a hard reset, the **Restore File** dialog box is displayed. Tap [Yes] to overwrite, tap [Yes To All] to overwrite all data, or tap [No] to leave the data.
When the backup data is restored, the CLIÉ handheld shuts down and restarts automatically.

Tips

- To restore backed up data by file, use the **Copy** feature in **CLIE Files**.
- For details on using **CLIE Files**, refer to “Exchanging data via “Memory Stick” media” on page 145.
- If you restore a file or back up a file, use the copy function of **CLIE Files**.
- For details, refer to “Exchanging data via “Memory Stick” media” on page 145.

Protecting your data with a password

This chapter explains how to manage your personal details using the various applications of your CLIÉ handheld and how to protect your data with a password.

Entering personal information	172
Locking your CLIÉ handheld with a password (Data protection)	174
Turning off your CLIÉ handheld after locking	174
Setting your CLIÉ handheld to be locked automatically	176
Protecting data	177
Assigning a password	177
Changing or deleting a password	178
Hiding or masking private data	179

Entering personal information

You can enter personal information, such as name, company name, and telephone number on your CLIE handheld. If you assign a password, the personal information will be displayed when your CLIE handheld is turned on next time.

- 1 Rotate the Jog Dial™ navigator to select  (Prefs) on the CLIE Launcher and press the Jog Dial™ navigator. The **Preferences** screen is displayed.

Tip

You can also tap  (Prefs) to display the **Preferences** screen.

- 2 Tap ▼ at the top right of the **Preferences** screen, and select [Owner]. The **Preferences** screen for [Owner] is displayed.

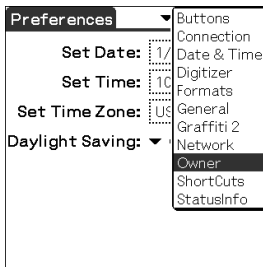

- 3 Enter your personal information. When entered character strings do not fit within the screen, a scroll bar is displayed on the right of the screen.

Continued on next page

If you have already assigned a password to protect your data

If personal information is already protected, it cannot be accessed or edited. To access/edit personal information, follow the steps below to unlock the protection.

- 1 Rotate the Jog Dial™ navigator to select  (Prefs) on the CLIE Launcher and press the Jog Dial™ navigator.
The **Preferences** screen is displayed.

Tip

You can also tap  (Prefs) to display the **Preferences** screen.

- 2 Tap ▼ at the top right of the **Preferences** screen, and select [Owner].
The **Preferences** screen for [Owner] is displayed.
- 3 Tap [Unlock].
The **Unlock Message** dialog box is displayed.



- 4 Enter the assigned password and tap [OK].

Locking your CLIÉ handheld with a password (Data protection)

You can lock your CLIÉ handheld by assigning a password. Your CLIÉ handheld then requires the user to enter the password when it is turned on.

Note

To turn on your CLIÉ handheld when it is locked, you must enter the correct password. If you forget the password, you need to perform a hard reset. However, performing a hard reset deletes all the data and applications which you installed on your CLIÉ handheld. (By performing the HotSync® operation, you can restore the backup data or applications from your computer.)

- ➔ For details on how to reset your CLIÉ handheld, refer to “Basic operations of your CLIÉ™ handheld: Restarting your CLIÉ™ handheld” in the “Read This First (Operating Instructions)”.

Turning off your CLIÉ handheld after locking

This feature locks and turns off your CLIÉ handheld. To turn on your CLIÉ handheld, you must enter the correct password.

- 1 Perform the HotSync® operation between your computer and CLIÉ handheld to create backup data from your CLIÉ handheld to your computer.
 - ➔ For details on the HotSync® feature, refer to “Backing up data and applications to your computer with the HotSync® operation” on page 167.
- 2 Rotate the Jog Dial™ navigator to select  (Security) on the CLIE Launcher and press the Jog Dial™ navigator. The **Security** screen is displayed.

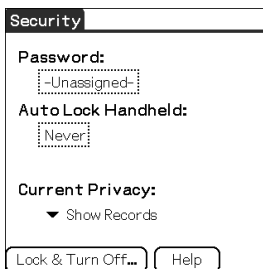

Tip

You can also tap  (Security) to display the **Security** screen.

Continued on next page

- 3 Follow “Assigning a password” on page 177 to assign a password.
- 4 Tap [Lock & Turn Off...].
The **System Lockout** screen is displayed.

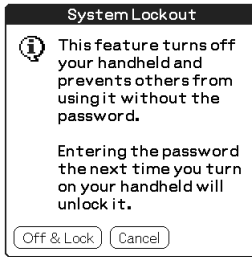

- 5 Tap [Off & Lock].
Your CLIÉ handheld turns off and locks.
To turn on your CLIÉ handheld, you must enter the correct password.

Setting your CLIÉ handheld to be locked automatically

You can set a time for your CLIÉ handheld to be locked automatically.

- 1 Follow steps 1 to 3 of “Turning off your CLIÉ handheld after locking” on page 174.
- 2 Tap [Never].
The **Password** dialog box is displayed.
- 3 Enter the password and tap [OK].
The **Lock Handheld** screen is displayed.

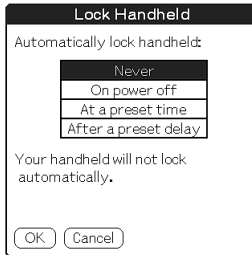

- 4 Tap your choice from the list on the **Lock Handheld** screen.
 - **Never:** Your CLIÉ handheld is not locked automatically.
 - **On power off:** Your CLIÉ handheld is locked when it is turned off.
 - **At a preset time:** Sets a time for your CLIÉ handheld to be locked automatically.
 - **After a preset delay:** Sets a time for your CLIÉ handheld to be locked automatically if it is inactive for a preset time interval.
- 5 Tap [OK].

Protecting data

You can protect your data from unauthorized users by assigning a password. Additionally, you can create private data which will not be shown even if a password is entered.

Assigning a password

You can assign a password to protect your private data or to lock your CLIE handheld.

- 1 Rotate the Jog Dial™ navigator to select  (Security) on the CLIE Launcher and press the Jog Dial™ navigator. The **Security** screen is displayed.

Tip

You can also tap  (Security) to display the **Security** screen.

- 2 Tap [-Unassigned-]. The **Password** screen is displayed.



- 3 Enter a password.
Enter up to 29 alphanumeric characters (in the range of a-z, 0-9).
- 4 Tap [OK].
The **Password** dialog box is displayed.
- 5 Enter the password once again to verify it and tap [OK].
Your password is assigned and [-Assigned-] is displayed on the screen in Step 2.

Continued on next page

Tip

In step 3, you can enter a hint to remember your password. The hint will be displayed to remind you of the correct password if you enter an incorrect password.

Changing or deleting a password

You can change or delete the assigned password.

- 1 Rotate the Jog Dial™ navigator to select  (Security) on the CLIE Launcher and press the Jog Dial™ navigator. The **Security** screen is displayed.

Tip

You can also tap  (Security) to display the **Security** screen.

- 2 Tap [-Assigned-].
The **Password** screen is displayed.
- 3 Enter the current password and tap [OK].
The **Password** dialog box is displayed.
- 4 Enter a new password and tap [OK].
To delete the password, tap [Unassign].

If you forget your password

If you forget your password, you can delete it forcibly. However, note that deleting the password forcibly also deletes all your private data. (If you perform the HotSync® operation to synchronize with your computer, you can restore your private data that has been backed up.)

- 1 In the above Step 2, tap [Lost Password].
The **Delete Password** dialog box is displayed.
- 2 Tap [Yes].
Your password and private data are deleted.

Hiding or masking private data

You can choose to hide or mask your private data in applications such as **Address Book** or **Memo Pad**. To view the private data, you need to enter the password. Even if the data is invisible, it is saved.

- 1 Rotate the Jog Dial™ navigator to select  (Security) on the CLIE Launcher and press the Jog Dial™ navigator. The **Security** screen is displayed.

Tip

You can also tap  (Security) to display the **Security** screen.

- 2 Tap ▼ under [Current Privacy...] to select [Mask Records] or [Hide Records]. The **Mask Records** dialog box or **Hide Records** dialog box is displayed.

- 3 Tap [OK]. The private data becomes invisible.

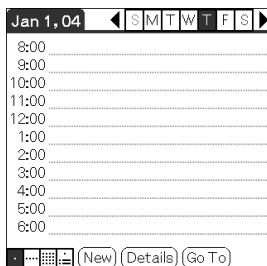

When you select [Hide Records]

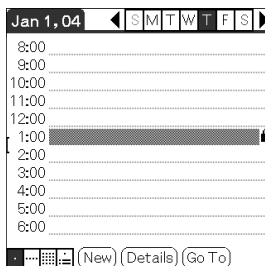

When you select [Mask Records]

Enhancing features with add-on applications

This chapter explains how to enhance features of your CLIE handheld by installing applications from your computer, Internet and “Memory Stick” media.

Enhancing features with add-on applications	181
Installing	182
Installing from your computer	182
Installing applications on “Memory Stick” media	184
Installing from the Internet	184
Deleting installed add-on applications	185

Enhancing features with add-on applications

To install the applications from the supplied CD-ROM, refer to “Installing the supplied applications on your CLIÉ handheld” in the “Read This First (Operating Instructions)”.

You can enhance the features of your CLIÉ handheld by installing applications such as games or other application that run on Palm OS (Add-on applications). For the latest information on the applications that can be used on your CLIÉ handheld, refer to your CLIÉ handheld support website.

For details of the website, refer to the URL shown on the last page of this manual.

Note

As add-on applications installed on your CLIÉ handheld are temporarily saved on the memory, the add-on applications will be deleted when a hard reset is performed. In this case, you would need to reinstall them on your CLIÉ handheld.

Installing from your computer

You can install the applications of your computer into your CLIÉ handheld.

For details on how to install the applications or data that are supplied with your CLIÉ handheld, refer to “Installing the supplied applications on your CLIÉ handheld” in the “Read This First (Operating Instructions)”.

- 1 Double-click  (Palm Desktop for CLIÉ) on the Windows desktop.
You can also click [Start], select [Programs] ([All Programs] for Windows XP) - [Sony Handheld], and click [Palm Desktop for CLIÉ].
Palm™ Desktop for CLIÉ starts.

- 2 Click [Install].
The **Install Tool** window is displayed.

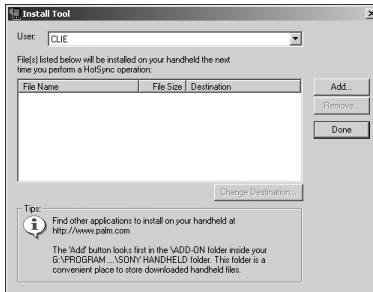

- 3 Select the user from [User...].
- 4 Click [Add...].
The **Open** dialog box is displayed.
The supplied applications or data are saved in the directory: Program Files/Sony Handheld/Add-on.

Continued on next page

5 Select applications you want to install from the folder and click [Open].

A list of the selected applications is displayed on the **Install Tool** window. Click [Remove...] to delete applications that you do not want to install. The applications will be deleted from the list, but not from your computer.

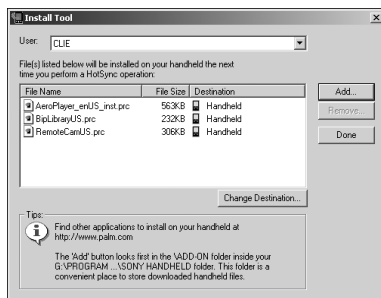

6 Click [Done].

The confirmation window is displayed.

7 Click [OK].

8 Perform the local HotSync® operation.

The applications selected in Step 5 are installed into your CLIE handheld.

- ➔ For details on the local HotSync® operation, refer to “Performing the HotSync® operation” on page 71.

Displaying the Install Tool window directly from the Start menu in Windows

To display the **Install Tool** window, click [Start], select [Programs] ([All Programs] for Windows XP) - [Sony Handheld], and click [Installation Tool]. You can also double-click files that can be installed, such as .prc or .pdb format files.

..... **Installing applications on “Memory Stick” media**

You can install an application into “Memory Stick” media by the following.

- Installing an application on “Memory Stick” media from your computer directly with **Data Import** and **Data Export**.
- After Step 5 of “Installing from your computer”, click [Change Destination]. Select the application and click either >> or << to specify [Memory Stick] for the location to save the application.

Notes on installing applications on “Memory Stick” media:

In some applications, related files, such as image files or movie files, cannot be opened (played back).

In the procedure mentioned above, select “Memory Stick” media and install the data or application onto the storage media you select by the HotSync[®] operation. They are installed in [/Palm/Launcher] directory. Some applications only support data in the designated directory. The data installed in [/Palm/Launcher] directory on “Memory Stick” media by the HotSync[®] operation cannot be displayed in those applications.

In this case, delete the data or applications from “Memory Stick” media using **CLIE Files**.

..... **Installing from the Internet**

You can download applications from the CLIE handheld support website and install them on your CLIE handheld.



For details of the website, refer to the URL shown on the last page of this manual.

- 1** Download the applications you want to install in your computer, from the Internet.
- 2** Follow the instructions including readme files to install the downloaded application on your CLIE handheld.
If there are no specific instructions, double-click the downloaded PRC format (.prc) file and perform step 6 through 8 of “Installing from your computer” on page 182.

Deleting installed add-on applications

Tip

You cannot delete the applications pre-installed on your CLIE handheld. Default applications, such as **Address Book** and **Memo Pad**, cannot be deleted.

- 1 Tap  (Home).
The CLIE Launcher is displayed.
- 2 Tap  (Menu).
The menu is displayed.
- 3 Tap [Delete...] from [CLIE Launcher].
The **Delete** screen is displayed.

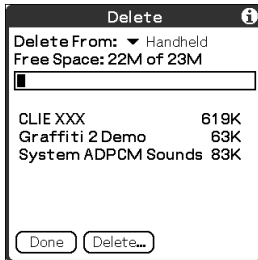

Tip

You can also tap  (Delete) to delete an application.

- 4 Tap ▼ next to [Delete From:] to select [Handheld] or [MS].
- 5 Tap the application you want to delete and tap [Delete...].
The **Delete Application** dialog box is displayed.



Continued on next page

- 6** Tap [Yes].
The application selected in Step 5 is deleted.
To cancel deleting, tap [No].
- 7** Tap [Done].
The CLIE Launcher is displayed.



Transferring data from another CLIÉ™ handheld

This chapter explains how to transfer data from your CLIÉ handheld to another CLIÉ handhelds.

Transferring data from another CLIÉ™ handheld	188
Transferring data using Palm™ Desktop for CLIÉ	188

Transferring data from another CLIÉ™ handheld

Notes

- **Memory Stick Backup** cannot transfer data of your CLIÉ handheld to another CLIÉ handheld.
- You cannot transfer applications that you installed. You need to reinstall them to your CLIÉ handheld.
- Some third party applications may operate only on your old CLIÉ handheld. For details, contact the application manufacturer.

Transferring data using Palm™ Desktop for CLIÉ

For data of the basic Palm OS® applications such as **Date Book**, **Address**, **To Do List**, and **Memo Pad**, you can use **Palm™ Desktop for CLIÉ** to transfer data from your old CLIÉ handheld to your new CLIÉ handheld, by exporting and importing data.

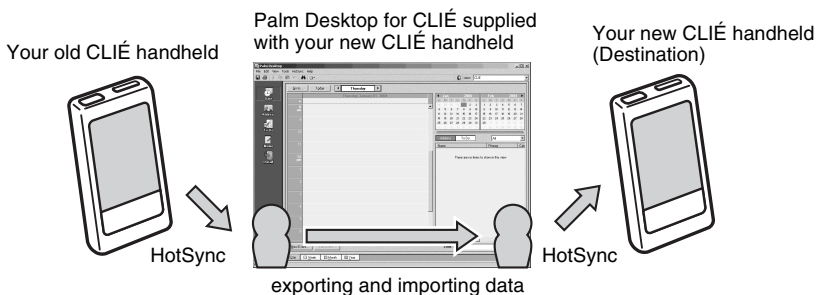

Note

To transfer data from your old CLIÉ handheld to your new CLIÉ handheld, use **Palm™ Desktop for CLIÉ** supplied with your new CLIÉ handheld, and perform the HotSync® operation with your old CLIÉ handheld. In this case, it requires that the user names of both your CLIÉ handheld is not the same.

Continued on next page

Exporting data from your old CLIÉ handheld to your computer

You can export the data of **Date Book**, **Address**, **To Do List**, and **Memo Pad** to your computer from your old CLIÉ handheld.

Note

Operate the following, after installing **Palm™ Desktop for CLIÉ** supplied with your new CLIÉ handheld to your computer.

If the other CLIÉ handheld is new, do not delete the old **Palm Desktop for CLIÉ** from your computer, but install (overwrite) the new **Palm Desktop for CLIÉ** (supplied with the new CLIÉ handheld) into your computer.

- 1 Connect your old CLIÉ handheld to your computer, and perform the HotSync® operation.
- 2 Double-click  (Palm Desktop for CLIÉ) on your Windows desktop.
Palm™ Desktop for CLIÉ starts.

Tip

You can also click [Start], select [Programs] ([All Programs] for Windows XP) - [Sony Handheld], and click [Palm Desktop for CLIÉ].

- 3 Select the user name of your previous CLIÉ handheld from the list at the top right of the screen.
- 4 Click  (Date Book) at the left side of the window.
The display is changed to the **Date Book** window.
- 5 Click [Export...] from [File].
The **Export** window is displayed.
- 6 Enter the file name and click [Export].
The data of your old CLIÉ handheld is exported.
Change the location to save the application as needed.
- 7 Repeat step 4 through 6 to export data of other applications.

Continued on next page

Importing data to your new CLIÉ handheld from your computer

You can import the data of **Date Book**, **Address**, **To Do List**, and **Memo pad** from your computer to your new CLIÉ handheld.

- 1 Select the user name of your new CLIÉ handheld from the list at the top right of the screen.

Tip

If you have never performed the HotSync® operation with your new CLIÉ handheld, select [Users...] from [Tools]. Click [New...] in the **Users** window and enter the new user name.

Then select the user name you just entered.

- 2 Click [Import...] from [File].
- 3 Select the files you have exported, and click [Open].
- 4 Perform the HotSync® operation.
The data exported from your old CLIÉ handheld is copied onto your new CLIÉ handheld.

Do not perform the HotSync® operation with the same user name as other CLIÉ handhelds

If you perform the HotSync® operation between your new CLIÉ handheld and **Palm™ Desktop for CLIÉ** for your old CLIÉ handheld, and use the old user name, then setup information specific to the old CLIÉ handheld will be transferred with data. This may cause some problems. Similarly, if you try performing the HotSync® operation with your old CLIÉ handheld, problems may also arise. Do not transfer data by this method.

The screen to select the user name is displayed when performing the HotSync® operation on your CLIÉ handheld

Enter a name that is different from the user name of your CLIÉ handheld being used. If the same user name is used, **Palm™ Desktop for CLIÉ** will not recognize your CLIÉ handheld properly and the data of the respective models will be mixed or deleted.

Moreover, if you copy [Unsaved Preferences] from another CLIÉ handheld to your CLIÉ handheld, you will not be able to manage your CLIÉ handheld with another name, since the user name is also copied.

INDEX

A

Application

- Add-on applications 181
- Deleting the add-on applications . . . 185
- Enhancing the features 181
- Installing from the Internet 184
- Installing from your computer 182
- Quitting 16
- Starting 14

Application buttons 99

Application manager icon

- Beam 24
- Delete 24
- Info 24

Archive 70, 113

Automatic power-off time 101

B

Backing up data

- Backing up data and applications to "Memory Stick" media using Memory Stick Backup 168
- Backing up data and applications to your computer with the HotSync® operation 167

Basic operations 10

Beam Receive feature

- Beaming 163
- IR HotSync 118
- Receiving 165
- What you can do 162

Brightness 100

Buttons 99, 100

C

CLIE Files

- Copying files/data on "Memory Stick" media to your CLIE handheld 151
- Copying your CLIE handheld files/data to "Memory Stick" media 148
- Deleting files/data on "Memory Stick" media 153
- Exchanging files/data without using CLIE Files 159
- Menu items 158
- Starting 145

CLIE Launcher

- Application Manager icon 24
- CLIE Launcher group 18
- Creating a new group 20
- Deleting a group 21
- Displaying information about applications 25
- Locating the components 17
- Menu List 27
- Ordering listed groups 20
- Selecting a group 21
- Using Favorite Applications (shortcuts) 22

Common menu items 43

Communication device 107

Conduit 111

Connection 107

Customizing the full-screen pen stroke activities 100

Continued on next page

D

Data protection	174
Date	106
Date Book	65
Decuma Input	45, 60
Digitizer	82
Dragging	11

E

Entering text	
Graffiti [®] 2 writing	46
Using Decuma Input	60

F

File Link	113
Finding	40
Fonts	42
Formats	106

G

General	101, 102, 103, 104
Graffiti [®] 2 writing	
Graffiti [®] 2 writing area	57
Using Navigation strokes and shortcuts	58
What is Graffiti [®] 2 writing?	46

H

Hide Records	179
Home screen	
CLIE Launcher	15
Palm OS Standard screen	29
HotSync	
Customizing HotSync [®] application settings (Conduit)	111
Customizing HotSync [®] Manager startup and HotSync [®] setup options	114
Performing the HotSync [®] operation	71
Performing the HotSync [®] operation via a modem	121
Performing the HotSync [®] operation via a network	127
Performing the HotSync [®] operation via a wireless LAN (for PEG-TJ37 only)	115
Performing the HotSync [®] operation via LAN (LANSync)	131
Performing the HotSync [®] operation with the USB cable (Local HotSync [®])	71
Performing the IR HotSync [®] operation	118
Synchronizing with external data (File Link)	113
What is the HotSync [®] operation?	69
HotSync [®] operation via a modem	121
HotSync [®] operation via a network	127

I

IR port	27, 118, 162
---------	--------------

Continued on next page

J

Jog Dial™ navigator 12

L

LANSync 131

Left button 21

Locking 174

Log-in scripts 95

M

Mask Records 179

Memory Stick Backup 168

"Memory Stick" media

 Assigning a name 142

 Exchanging files/data 145

 Formatting 143

 Protecting the files/data on

 "Memory Stick" media 138

 Starting an application 139

 The type of "Memory Stick" media you
 can use with your CLIÉ handheld . . . 135

 The type of storage media you can use
 with your CLIÉ handheld 135

 Using "Memory Stick" media 135

 Viewing information 141

N

Network 88

Network Log 98

Numbers

 Selecting a regional default 106

O

Owner 172

P

Palm™ Desktop for CLIÉ software

 Basic operations 75

 Locating components 74

 Starting 73

 Transferring data from another CLIÉ

 handheld 188

Password

 Changing or deleting 178

 If you forget your password 178

Preferences

 Buttons 99, 100

 Connection 107

 Date & Time 108

 Digitizer 82

 Formats 106

 General 101, 102, 103, 104

 Network 88

 Owner 172

 ShortCuts 80

Private data 177

Protecting 177

R

**Restoring backup data and
applications** 169

Right button 21

S

Service template 88, 92, 94

Setting up the Date &

Time preferences 108

ShortCuts 17, 58, 80

Sounds 102

Stylus 10

Continued on next page

T

Tapping	11
Time	106
Transferring data	188

U

User name	111, 115, 127
Using Favorite Applications (shortcuts)	
Creating	22
Deleting	24
Using the Palm OS [®] Standard screen	
Changing the display style of the Palm OS [®] Standard screen	36
Starting an application	31
Switching to the CLIE Launcher screen	30

V

View Log	98
----------	----

W

Wireless LAN	
Adhoc mode	83
Checking the wireless LAN communication status	87
Connecting your CLIE [®] handheld to a wireless LAN access point automatically	86
Searching and setting a wireless LAN access point manually	85
Setting a wireless LAN access point manually	83
Setting the Network preferences for a wireless LAN (for PEG-TJ37 only)	83

For the latest information on support CLIE products and accessories, check our official Sony CLIE website

For customers in the U.S.A. and Canada

<http://www.sony.com/clie/>

For customers in Australia, Hong Kong, Malaysia, Mexico, New Zealand, Singapore, Taiwan, Thailand, and U.A.E.

<http://www.sony.net/clie-online/>

For customers in Europe

<http://www.sony-europe.com/clie>